



Marine Safety Center Technical Note

MTN 01-99 CH-10
16717/46CFR69/P009017
February 28, 2020

Subj: TONNAGE TECHNICAL POLICY

1. **Purpose:** This Technical Note promulgates policy for use by authorized measurement organizations in applying and interpreting provisions of the tonnage regulations (Title 46, Code of Federal Regulations, Part 69 (46 CFR 69), *Measurement of Vessels*.) It replaces MTN 01-99 Change 9.
2. **Discussion:** This Technical Note provides interpretations of the tonnage regulations through a reprint of the regulations in standard font, with interpretations inserted in italics font and interpretive figures added in appropriate locations. Appendices address grandfathering provisions for superseded interpretations, provide related interpretations of, and recommendations for, the International Convention on Tonnage Measurement of Ships, 1969 (the 1969 Tonnage Convention), and discuss changes from the previous version of this Technical Note. Side bars are used throughout this Technical Note to identify substantive changes. The pages are numbered sequentially from the beginning of the document to facilitate electronic use.
3. **Applicability:** Tonnage measurement under the tonnage regulations and the policy of this Technical Note is required for vessels for which the application of a law of the United States depends on the vessel's tonnage. Refer to MTN 01-98 as amended, *Tonnage Administrative Policy*, for additional information on administrative matters related to tonnage measurement.
4. **Action:** Authorized measurement organizations shall apply the interpretations of this Technical Note immediately. Any deviation from the interpretations of this Technical Note requires written approval from the Marine Safety Center (MSC). This Technical Note is available at <http://www.uscg.mil/hq/msc>.
5. **Disclaimer:** This guidance is not a substitute for applicable legal requirements, nor is it itself a rule. It is not intended to nor does it impose legally-binding requirements on any party. It represents the Coast Guard's current thinking on this topic and may assist industry, mariners, the general public, and the Coast Guard, as well as other federal and state regulators, in applying statutory and regulatory requirements. You can use an alternative approach for complying with these requirements if the approach satisfies the requirements of the applicable statutes and regulations. If you want to discuss an alternative approach (you are not required to do so), you may contact the Marine Safety Center (MSC-4), which is responsible for implementing this guidance.

S. J. KELLY

(Page intentionally left blank)

TABLE OF CONTENTS

TABLE OF CONTENTS.....3

GENERAL9

§ 69.1 Purpose9

§ 69.3 Applicability9

§ 69.5 [Reserved]9

§ 69.7 Vessels Transiting the Panama and Suez Canals9

§ 69.9 Definitions9

§ 69.11 Determining the Measurement System or Systems for a Particular Vessel12

 (a) *Convention Measurement System (subpart B of this part)*12

 (b) *Standard Regulatory Measurement System (subpart C of this part)*12

 (c) *Dual Regulatory Measurement System (subpart D of this part)*12

 (d) *Simplified Regulatory Measurement System (subpart E of this part)*12

§ 69.13 Applying Provisions of a Measurement System12

 (a) *Coast Guard Interpretations*12

 (b) *Interchangeability of Measurement Systems*13

 (c) *Grandfathering of Rules and Procedures*13

§ 69.15 Authorized Measurement Organizations13

 (a) *Formal Measurement*13

 (b) *Simplified Measurement*13

 (c) *Warship Measurement*13

 (d) *Optional Coast Guard Measurement*13

 (e) *Tonnage Certificate Issuance*13

§ 69.17 Application for Measurement Services13

 (a) *General*13

 (b) *Combined Applications*13

 (c) *Early Submission*14

§ 69.19 Remeasurement14

 (a) *Vessel Changes*14

 (b) *Errors and Current Rule Application*14

 (c) *Certificate Reissuance*14

 (d) *Optional Simplified Measurement*14

§ 69.20 Applying Tonnage Thresholds14

 (a) *General*14

 (b) *Thresholds Found in International Conventions*15

 (c) *Thresholds Found in Federal Statutes and Regulations*15

 (d) *Alternate Tonnage Thresholds*16

§ 69.21 Right of Appeal16

§ 69.23 Fees16

§ 69.25 Penalties16

 (a) *General violation*16

 (b) *False Statements*16

§ 69.27 Delegation of Authority to Measure Vessels17

 (a) *Statutory Authority*17

 (b) *Delegation to Measurement Organizations*17

 (c) *Applying for Delegation*17

 (d) *Written Agreement*17

§ 69.28 Acceptance of Measurement by a Foreign Country18

 (a) *Convention Measurement System Compliance*18

 (b) *Regulatory Measurement System Compliance*18

§ 69.29 OMB Control Numbers Assigned Under the Paperwork Reduction Act19

 (a) *Purpose*19

 (b) *Display*19

CONVENTION MEASUREMENT SYSTEM21

§ 69.51 Purpose21

§ 69.53 Definitions21

§ 69.55 Application for Measurement22

§ 69.57 Gross Tonnage ITC	22
§ 69.59 Enclosed Spaces	23
§ 69.61 Excluded Spaces	23
(a) <i>General</i>	23
(b) <i>Space Opposite End Openings</i>	23
(c) <i>Covered Space Open on Sides</i>	23
(d) <i>Covered Space in Way of Side Openings</i>	24
(e) <i>Space Below Uncovered Opening</i>	24
(f) <i>Recesses</i>	24
(g) <i>Additional Restrictions on Excluded Spaces</i>	24
§ 69.63 Net Tonnage ITC	25
§ 69.65 Calculation of Volumes	25
(a) <i>Naval Architectural Practices</i>	25
(b) <i>Termination of Measurements</i>	27
§ 69.67 Marking of Cargo Spaces	27
§ 69.69 Tonnage Certificate	27
(a) <i>International Tonnage Certificate (1969)</i>	27
(b) <i>U.S. Tonnage Certificate</i>	28
(c) <i>Flag Transfer</i>	28
§ 69.71 Change of Net Tonnage	28
(a) <i>Net Tonnage Increases</i>	28
(b) <i>Vessel With Different Load Line Assignments</i>	28
(c) <i>Net Tonnage Decreases</i>	28
§ 69.73 Treatment of Novel Type Vessels	28
(a) <i>Novel Vessel Determinations</i>	28
(b) <i>Submittal of Determination Requests</i>	28
§ 69.75 Figures	29
STANDARD REGULATORY MEASUREMENT SYSTEM.....	31
§ 69.101 Purpose	31
§ 69.103 Definitions	31
§ 69.105 Application for Measurement Services	33
§ 69.107 Gross and Net Register Tonnage	33
(a) <i>Gross Register Tonnage</i>	33
(b) <i>Net Register Tonnage</i>	34
§ 69.108 Uppermost Complete Deck	34
(a) <i>Defined</i>	34
(b) <i>Restrictions</i>	34
(c) <i>Deck discontinuities</i>	35
§ 69.109 Under-Deck Tonnage	35
(a) <i>Defined</i>	35
(b) <i>Method of Calculating Tonnage</i>	35
(c) <i>Identifying the Tonnage Deck</i>	35
(d) <i>Enumerating the Decks to Identify the Second Deck from the Keel</i>	36
(e) <i>Identifying the Line of the Tonnage Deck</i>	36
(f) <i>Tonnage Length</i>	36
(g) <i>Division of Vessel into Transverse Sections</i>	39
(h) <i>Depths of Transverse Sections (see also § 69.109(p) and (q))</i>	40
(i) <i>Breadths of Transverse Sections (see also § 69.109(p) and (q))</i>	42
(j) <i>Measuring Spaces Having Ceiling</i>	43
(k) <i>Area of Transverse Sections</i>	43
(l) <i>Calculating Tonnage From Sectional Areas</i>	44
(m) <i>Steps in Double Bottom for Water Ballast</i>	44
(n) <i>Spaces Open to the Sea</i>	44
(o) <i>Open Vessels</i>	44
(p) <i>General Requirements on Ordinary Frames</i>	45
(q) <i>Unconventional Hull Forms</i>	56
§ 69.111 Between-Deck Tonnage	60
(a) <i>Between-Deck Tonnage Defined</i>	60

(b) *Identifying the Line of the Uppermost Complete Deck* 60

(c) *Method of Calculating Tonnage*..... 61

§ 69.113 Superstructure Tonnage..... 61

(a) *Superstructure Tonnage Defined* 61

(b) *Method of Calculating Tonnage* 62

(c) *Treatment of Stepped Decks/Sides* 62

(d) *Computing Superstructure Tonnage*..... 62

(e) *Treatment of Spaces Open to Under-Deck*..... 62

(f) *Method of Calculating Tonnage (Standard Shapes)*..... 62

§ 69.115 Excess Hatchway Tonnage..... 63

(a) *Applicability*..... 63

(b) *Method of Calculating Tonnage* 63

(c) *Determining Excess Hatchway Tonnage*..... 63

§ 69.117 Spaces Exempt From Inclusion in Tonnage 63

(a) *Purpose*..... 63

(b) *Spaces On or Above the Line of the Uppermost Complete Deck*..... 63

(c) *Passenger Spaces*..... 64

(d) *Open Structures* 65

(e) *Open Space Between the Shelter Deck and the Uppermost Complete Deck*..... 76

(f) *Water Ballast Spaces* 77

(g) *Methods for Measuring Exempt Spaces*..... 79

§ 69.119 Spaces Deducted From Gross Tonnage..... 81

(a) *Purpose*..... 81

(b) *General*..... 81

(c) *Anchor Gear*..... 82

(d) *Boatswain’s Stores*..... 82

(e) *Chart Room*..... 82

(f) *Donkey Engine and Boiler*..... 82

(g) *Spaces for the Exclusive Use of Officers or Crew* 82

(h) *Master’s Cabin* 83

(i) *Radio Room* 83

(j) *Steering Gear*..... 83

(k) *Generators* 83

(l) *Pump Room* 83

(m) *Sail Stowage*..... 83

(n) *Waste Material Space* 83

(o) *Passageways*..... 84

(p) *Markings for Deductible Spaces*..... 84

(q) *Method for Measuring Deductible Spaces*..... 84

§ 69.121 Engine Room Deduction 85

(a) *General*..... 85

(b) *Propelling Machinery Spaces*..... 86

(c) *Methods for Measuring Propelling Machinery Spaces*..... 87

(d) *Engine Room Spaces Above Line of the Uppermost Complete Deck*..... 89

(e) *Calculating the Engine Room Deduction*..... 89

§ 69.123 Figures..... 91

DUAL REGULATORY MEASUREMENT SYSTEM..... 95

§ 69.151 Purpose 95

§ 69.153 Application of Other Laws 95

(a) *Use of Higher Tonnage*..... 95

(b) *Load Line Requirements* 95

§ 69.155 Measurement Requirements 95

§ 69.157 Definitions 95

§ 69.159 Application For Measurement Services..... 96

§ 69.161 Gross and Net Register Tonnages 96

§ 69.163 Under-Deck Tonnage 96

§ 69.165 Between-Deck Tonnage 96

§ 69.167 Superstructure Tonnage..... 97

§ 69.169 Spaces Exempt From Inclusion In Tonnage.....	97
(a) Miscellaneous Exemptible Superstructure Spaces.....	97
(b) Passenger Spaces.....	97
(c) Water Ballast Spaces.....	97
(d) Dry Cargo and Stores Spaces.....	97
(e) Additional Exemptions for Low Tonnage.....	97
§ 69.171 When the Tonnage Mark is Considered Submerged.....	98
§ 69.173 Tonnage Assignments For Vessels With Only One Deck.....	98
§ 69.175 Tonnage Assignments For Vessels With a Second Deck.....	98
§ 69.177 Markings.....	99
(a) Tonnage Mark.....	99
(b) Line For Fresh and Tropical Waters.....	101
(c) Freeboard Deck Mark.....	101
(d) The Line of the Second Deck.....	101
(e) Color of Markings.....	101
§ 69.179 Certification of Markings.....	101
(a) Measurement Organization Certification.....	101
(b) Coast Guard Verification.....	102
§ 69.181 Locating the Line of the Second Deck.....	102
(a) Second Deck Not Stepped.....	102
(b) Second Deck Stepped.....	102
§ 69.183 Figures.....	103
(a) Tonnage Mark Triangle.....	103
(b) Tonnage Mark Location (High and Low Tonnages).....	103
(c) Tonnage Mark Location (Low Tonnages Only).....	104
SIMPLIFIED REGULATORY MEASUREMENT SYSTEM.....	105
§ 69.201 Purpose.....	105
§ 69.203 Definitions.....	105
§ 69.205 Application For Measurement Services.....	107
§ 69.207 Measurements.....	108
§ 69.209 Gross and Net Register Tonnages.....	108
(a) Gross Register Tonnage.....	108
(b) Net Register Tonnage.....	110
(c) Certification of Measurement.....	110
§ 69.211 Treatment of Novel Type Vessels.....	110
APPENDIX A GRANDFATHERING PROVISIONS.....	111
§ A.1 Purpose.....	111
§ A.2 Discussion.....	111
§ A.3 Grandfathering Authorization.....	111
§ A.4 Consideration of Other Vessels.....	111
APPENDIX B 1969 TONNAGE CONVENTION.....	113
Article 1 General Obligation Under the Convention.....	113
Article 2 Definitions.....	113
Article 3 Application.....	115
Article 4 Exceptions.....	115
Article 5 Force Majeure.....	116
Article 6 Determination of Tonnages.....	116
Article 7 Issue of Certificate.....	116
Article 8 Issue of Certificate by Another Government.....	116
Article 9 Form of Certificate.....	116
Article 10 Cancellation of Certificate.....	117
Article 11 Acceptance of Certificate.....	117
Article 12 Inspection.....	117
Article 13 Privileges.....	118
Article 14 Prior Treaties, Conventions and Arrangements.....	118
Article 15 Communication of Information.....	118
Article 16 Signature, Acceptance and Accession.....	118
Article 17 Coming into Force.....	119

Article 18 Amendments.....	119
Article 19 Denunciation	120
Article 20 Territories	121
Article 21 Deposit and Registration	121
Article 22 Languages.....	121
Annex I Regulations for Determining Gross and Net Tonnages of Ships	122
Regulation 1 General.....	122
Regulation 2 Definitions of Terms Used in the Annexes	122
Regulation 3 Gross Tonnage	136
Regulation 4 Net Tonnage.....	136
Regulation 5 Change of Net Tonnage	137
Regulation 6 Calculation of Volumes	138
Regulation 7 Measurement and Calculation.....	139
Appendix 1 Figures Referred to in Regulation 2(5)	140
Appendix 2 Coefficients K1 and K2 Referred to in Regulations 3 and 4(1).....	143
Annex II Certificate.....	144
Annex III Verification of Compliance with the Provisions of this Convention	146
Regulation 8 Application.....	146
Regulation 9 Verification of Compliance.....	146
Novel Craft Interpretations (Regulation 1(3))	147
Annex to Circular TM.5/Circ.6	150
APPENDIX C RECOMMENDATIONS OF THE CONFERENCE	151
APPENDIX D DISCUSSION OF CHANGES.....	153

(Page intentionally left blank)

GENERAL (46 CFR 69 Subpart A with Interpretations)

§ 69.1 PURPOSE

This part implements legislation concerning the measurement of vessels to determine their tonnage (part J of 46 U.S.C. subtitle II). Tonnage is used for a variety of purposes, including the application of vessel safety, security, and environmental protection regulations and the assessment of taxes and fees. This part indicates the particular measurement system or systems under which the vessel is required or eligible to be measured, describes the application and measurement procedures for each system, identifies the organizations authorized to measure vessels under this part, and provides for the appeal of measurement organizations' decisions.

§ 69.3 APPLICABILITY

This part applies to any vessel for which the application of an international agreement or other law of the United States to the vessel depends on the vessel's tonnage.

§ 69.5 [RESERVED]

§ 69.7 VESSELS TRANSITING THE PANAMA AND SUEZ CANALS

For vessels that will transit the Panama Canal and/or Suez Canal, the respective canal authorities may require special tonnage certificates in addition to those issued under this part. These special certificates may be issued by measurement organizations who have received appropriate authorization from the respective canal authorities.

§ 69.9 DEFINITIONS

As used in this part—

Authorized measurement organization means an entity that is authorized to measure vessels under this part.

Commandant means Commandant of the Coast Guard at the following address: Commanding Officer, Marine Safety Center (MSC-4), U.S. Coast Guard Stop 7430, 2703 Martin Luther King Jr. Ave. SE., Washington, DC 20593-7430.

Convention means the International Convention on Tonnage Measurement of Ships, 1969.

Convention Measurement System means the measurement system under subpart B of this part, which is based on the rules of the Convention. This Formal Measurement System uses the vessel's total enclosed volume as the principal input for tonnage calculations along with other characteristics related to the vessel's carrying capacity, including the volume of cargo spaces and number of passengers. Tonnages assigned under this system are expressed in terms of gross tonnage ITC (GT ITC) or net tonnage ITC (NT ITC).

Deck cargo means freight carried on the weather decks of a vessel for the purpose of its transport between two separate and distinct locations, and which is off-loaded from the vessel in its original container (if applicable) without undergoing any processing or other use while onboard the vessel. *For example, a JP-5 fuel tank being transported to an offshore platform and hoisted on board the platform with its original contents intact is considered deck cargo. If for the same tank, shipboard pumps were used to off-load the JP-5 to the platform, the tank would be considered temporary deck equipment, and not deck cargo. Note that the method of attachment does not determine whether an item is considered deck cargo. A bona fide shipping container can either be lashed or welded to the deck, provided it meets all the criteria for deck cargo as outlined above.*

Dual Regulatory Measurement System means the system under subpart D of this part, which is one of three sub-systems of the Regulatory Measurement System. This Formal Measurement System is based on the rules

of the Standard Regulatory Measurement System, with adjustments that allow for the assignment of two sets of Regulatory Measurement System tonnages whose use depends on the loading condition of the vessel. Tonnages assigned under this system are expressed in terms of gross register tons (GRT) or net register tons (NRT).

Foreign flag vessel means a vessel that is not a U.S. flag vessel.

Formal Measurement System means a measurement system that employs a detailed computational method using measurements of the entire vessel, and which also takes into account the use of vessel spaces. The measurement systems prescribed under Subparts B, C, and D of this part are Formal Measurement Systems.

Great Lakes means the Great Lakes of North America and the St. Lawrence River west of a rhumb line drawn from Cap des Rosiers to West Point, Anticosti Island, and, on the north side of Anticosti Island, the meridian of longitude 63 degrees west.

Gross register tonnage (GRT) means the gross tonnage measurement of the vessel under the Regulatory Measurement System. Refer to § 69.20 of this subpart for information on applying tonnage thresholds expressed in terms of gross register tons (also referred to as GRT).

Gross tonnage ITC (GT ITC) means the gross tonnage measurement of the vessel under the Convention Measurement System. In international conventions, this parameter may be referred to as “gross tonnage (GT).” Refer to § 69.20 of this subpart for information on applying tonnage thresholds expressed in terms of gross tonnage ITC.

Keel laid date means the date that a vessel’s keel was laid or was at a similar stage of construction. The term “similar stage of construction” means the stage at which construction identifiable with a specific vessel began, and assembly of this vessel commenced comprising at least 50 metric tons or one percent of the estimated mass of all structural material, whichever is less.

National Vessel Documentation Center (NVDC) means the organizational unit designated by the Commandant to process vessel documentation transactions and maintain vessel documentation records.

Net register tonnage (NRT) means the net tonnage of the vessel under the Regulatory Measurement System. Refer to § 69.20 of this subpart for information on applying tonnage thresholds expressed in terms of net register tons.

Non-self-propelled vessel means a vessel that is not a self-propelled vessel.

Overall length means the horizontal distance of the vessel’s hull between the foremost part of a vessel's stem to the aftermost part of its stern, excluding fittings and attachments.

Portable enclosed space (formerly “temporary deck equipment”) means an enclosed space that is not deck cargo, and whose method of attachment to the vessel is not permanent in nature. Examples of portable enclosed spaces include modular living quarters, housed portable machinery spaces, and deck tanks used in support of shipboard industrial processes.

Register ton means a unit of volume equal to 100 cubic feet.

Regulatory Measurement System means the measurement system that comprises subparts C, D, and E of this part (Standard, Dual, and Simplified Regulatory Measurement Systems, respectively), and is sometimes referred to as the national measurement system of the United States. Tonnages assigned under this system are expressed in terms of gross register tons (GRT) or net register tons (NRT).

Remeasurement means the process by which tonnages or registered dimensions of a vessel that was previously measured are assigned or reassigned to that vessel, or are verified to be correct, as appropriate. This includes assignment of tonnages or registered dimensions under a different measurement system.

Self-propelled vessel means a vessel with a means of self-propulsion, including sails.

Simplified Regulatory Measurement System means the measurement system under subpart E of this part, which is one of three sub-systems of the Regulatory Measurement System. It is based on the rules of the Standard Regulatory Measurement System but employs a simplified computational method using hull dimensions as the principal inputs. Tonnages assigned under this system are expressed in terms of gross register tons (GRT) or net register tons (NRT).

Standard Regulatory Measurement System means the measurement system under subpart C of this part, which is one of three sub-systems of the Regulatory Measurement System. This Formal Measurement System is based on the rules of the British Merchant Shipping Act of 1854 and uses volumes of internal spaces as the principal inputs for tonnage calculations, allowing for exemptions or deductions of qualifying spaces according to their location and use. Tonnages assigned under this system are expressed in terms of gross register tons (GRT) or net register tons (NRT).

Substantially altered means the vessel has undergone changes of sufficient magnitude to necessitate a remeasurement, and which include alterations that increase or decrease the gross tonnage ITC by more than 1%. In most cases, addition or removal of portable enclosed spaces does not involve alterations to a vessel, and therefore would have no bearing on whether or not a vessel is substantially altered.

Substantially altered date means the date a substantial alteration on a vessel was commenced.

Tonnage means the volume of a vessel's spaces, including portable enclosed spaces, as calculated under a measurement system in this part, and is categorized as either gross or net. Gross tonnage refers to the volumetric measure of the overall size of a vessel. Net tonnage refers to the volumetric measure of the useful capacity of the vessel. Deck cargo is not included in tonnage.

Tonnage threshold means a delimitating tonnage value specified in an international convention or a Federal statute or regulation.

U.S. flag vessel means a vessel of United States registry or nationality, or one operated under the authority of the United States.

Vessel of war means “vessel of war” as defined in 46 U.S.C. 2101.

Vessel that engages on a foreign voyage means a vessel—

- (a) That arrives at a place under the jurisdiction of the United States from a place in a foreign country;
- (b) That makes a voyage between places outside of the United States;
- (c) That departs from a place under the jurisdiction of the United States for a place in a foreign country; or
- (d) That makes a voyage between a place within a territory or possession of the United States and another place under the jurisdiction of the United States not within that territory or possession. *The Commonwealth of Puerto Rico is considered to be a “territory or possession” of the United States, so a voyage between Miami, FL and San Juan, Puerto Rico is a foreign voyage.*

§ 69.11 DETERMINING THE MEASUREMENT SYSTEM OR SYSTEMS FOR A PARTICULAR VESSEL

(a) Convention Measurement System (subpart B of this part)

- (1) Except as otherwise provided in this section, this Formal Measurement System applies to any vessel for which the application of an international agreement or other law of the United States to the vessel depends on the vessel's tonnage.
- (2) This system does not apply to the following vessels:
 - (i) A vessel of war unless the government of the country to which the vessel belongs elects to measure the vessel under this chapter.
 - (ii) A vessel of less than 79 feet in overall length.
 - (iii) A U.S. flag vessel, or one of Canadian registry or nationality, or operated under the authority of Canada, and that is operating only on the Great Lakes, unless the owner requests.
 - (iv) A U.S. flag vessel (except a vessel that engages on a foreign voyage), the keel of which was laid or was at a similar stage of construction before January 1, 1986, unless the owner requests or unless the vessel subsequently undergoes a change that the Commandant finds substantially affects the gross tonnage (*i.e., is substantially altered.*)
 - (v) A non-self-propelled U.S. flag vessel (except a non-self-propelled vessel that engages on a foreign voyage) unless the owner requests the application.

(b) Standard Regulatory Measurement System (subpart C of this part)

This Formal Measurement System applies to a vessel not measured under the Convention Measurement System for which the application of an international agreement or other law of the United States to the vessel depends on the vessel's tonnage. Upon request of the vessel owner, this system also applies to a documented U.S. flag vessel that is also measured under the Convention Measurement System.

(c) Dual Regulatory Measurement System (subpart D of this part)

This Formal Measurement System may be applied, at the vessel owner's option, instead of the Standard Measurement System.

(d) Simplified Regulatory Measurement System (subpart E of this part)

This system may be applied, at the vessel owner's option, instead of the Standard Measurement System to the following vessels:

- (1) A vessel that is under 79 feet in overall length.
- (2) A vessel of any length that is non-self-propelled.
- (3) A vessel of any length that is operated only for pleasure.

§ 69.13 APPLYING PROVISIONS OF A MEASUREMENT SYSTEM

(a) Coast Guard Interpretations

Except as noted under paragraph (c) of this section, all provisions of a measurement system as prescribed in this part that are applicable to the vessel must be observed. Coast Guard interpretations

of these provisions are published by, and may be obtained from, Commanding Officer, Marine Safety Center (MSC-4).

(b) *Interchangeability of Measurement Systems*

The provisions of more than one measurement system must not be applied interchangeably or combined, except where specifically authorized under this part.

(c) *Grandfathering of Rules and Procedures*

Unless otherwise provided for by law, the tonnage measurement rules and procedures that immediately predate the rules and procedures prescribed in this part may be applied, at the option of the vessel owner, to the following vessels:

- (1) A vessel which has not been measured and which was contracted for on or before May 2, 2016.
- (2) A vessel which has been measured, but which has undergone modifications contracted for on or before May 2, 2016.

§ 69.15 AUTHORIZED MEASUREMENT ORGANIZATIONS

(a) *Formal Measurement*

Except as noted under paragraphs (c) and (d) of this section, measurement or remeasurement of all vessels under the Convention Measurement System and Standard and Dual Regulatory Measurement Systems must be performed by an authorized measurement organization meeting the requirements of § 69.27 of this subpart. A current listing of authorized measurement organizations can be obtained from the Commanding Officer, Marine Safety Center (MSC-4).

(b) *Simplified Measurement*

Measurement or remeasurement of all vessels under subpart E of this part must be performed by the Coast Guard.

(c) *Warship Measurement*

Measurement or remeasurement of all U.S. Coast Guard vessels and all U.S. Navy vessels of war (*warships*) must be performed by the Coast Guard.

(d) *Optional Coast Guard Measurement*

At the option of the Commandant, the Coast Guard may measure any vessel under this part.

(e) *Tonnage Certificate Issuance*

The appropriate tonnage certificate, as provided for under this part, is issued by the authorized measuring organization as evidence of the vessel's measurement under this part.

§ 69.17 APPLICATION FOR MEASUREMENT SERVICES

(a) *General*

The vessel owner is responsible for having the vessel measured or remeasured under this part. Applications for Formal Measurement may be obtained from any measurement organization and, once completed, are submitted to the authorized measurement organization that will perform the measurement services. Applications for Simplified Measurement may be obtained from the Commanding Officer, Marine Safety Center (MSC-4) and, once completed, are submitted or retained as described in § 69.205. The contents of the application are described in this part under the requirements for each system.

(b) *Combined Applications*

Applications for measurement under more than one system may be combined.

(c) ***Early Submission***

For vessels under construction, the application should be submitted before the vessel is advanced in construction. Usually, this means as soon as the decks are laid, holds cleared of encumbrances, engines installed, and accommodations partitioned.

§ 69.19 REMEASUREMENT

(a) ***Vessel Changes***

If a vessel that is already measured is to undergo a structural alteration, a change to its service, or if the use of its space is to be changed, a remeasurement may be required. For vessels measured under a Formal Measurement System, owners must report immediately to an authorized measurement organization any intent to structurally alter the vessel or to change the use of its space. The measurement organization advises the owner if remeasurement is necessary. For all other vessels, owners must report the intent to structurally alter the vessel to Commanding Officer, Marine Safety Center (MSC-4), for a remeasurement determination. Remeasurement is initiated by completing and submitting, where applicable, the appropriate application for measurement services. Spaces not affected by the alteration or change need not be remeasured. (*See MTN 01-98 as amended for Coast Guard policy on remeasurement determinations.*)

(b) ***Errors and Current Rule Application***

Remeasurement must also be performed as follows:

- (1) When there is a perceived error in the application of this part, the vessel owner should contact the responsible measurement organization, or Commanding Officer, Marine Safety Center (MSC-4), as appropriate. Remeasurement is performed to the extent necessary to verify and correct the error.
- (2) At the vessel owner's option, to reflect the latest tonnage measurement rules and associated interpretations under this part.

(c) ***Certificate Reissuance***

For vessels measured under a Formal Measurement System, if a remeasurement or adjustment of tonnage is required, the authorized measurement organization will issue a new tonnage certificate. For all other vessels, Commanding Officer, Marine Safety Center (MSC-4) will take action, as appropriate.

(d) ***Optional Simplified Measurement***

A vessel of less than 79 feet in overall length measured under a Formal Measurement System may be remeasured at the owner's request under the Simplified Measurement System.

§ 69.20 APPLYING TONNAGE THRESHOLDS

(a) **General**

Tonnage thresholds are applied using the vessel's tonnage assigned under this part, and as provided for by paragraphs (b) through (d) of this section. In general, and except as under paragraphs (b) and (c) of this section, tonnage thresholds expressed in terms of "gross tonnage," "gross tonnage ITC," or "GT ITC" are applied using Convention Measurement System tonnage (if assigned) and thresholds expressed in terms of "gross tons," "registered gross tons," or "GRT" are applied using the Regulatory Measurement System tonnage (if assigned). Similarly, in general, and except as under paragraphs (b) and (c) of this section, tonnage thresholds expressed in terms of "net tonnage," "net tonnage ITC," or "NT ITC" are applied using Convention Measurement System tonnage (if assigned) and thresholds expressed in terms of "net tons," "registered net tons," or "NRT" are applied using the Regulatory Measurement System tonnage (if assigned).

(b) Thresholds Found in International Conventions¹

Unless otherwise provided for by law, apply tonnage thresholds in international conventions as follows:

- (1) For vessels measured under the Convention Measurement System, apply all tonnage thresholds using Convention Measurement System tonnage, except as provided for under the following international tonnage grandfathering provisions, which may be applied at the option of the vessel owner:
 - (i) Article 3(2)(d) of the Convention.
 - (A) For a U.S. flag vessel, this Article allows associated tonnage thresholds in effect on or before July 18, 1994 to be applied, at the vessel owner's option, using Regulatory Measurement System tonnage to a vessel whose keel was laid on or before July 18, 1982, and which did not subsequently undergo alterations resulting in a change in its tonnage of a magnitude deemed by the Commandant to constitute a substantial variation in its tonnage (*i.e., is substantially altered.*)
 - (B) For a foreign flag vessel, this Article allows associated tonnage thresholds in effect on or before July 18, 1994, to be applied, at the vessel owner's option, using the foreign country's national measurement system tonnage to a vessel whose keel was laid on or before July 18, 1982, and which did not subsequently undergo alterations resulting in a change in its tonnage of a magnitude deemed by that country to constitute a substantial variation in its tonnage.
 - (ii) Under International Maritime Organization (IMO) Resolutions A.494 (XII) of November 19, 1981 and A.541 (XIII) of November 17, 1983.
 - (A) For a U.S. flag vessel, these resolutions allow tonnage thresholds in effect on July 18, 1994 to be applied using the gross register tonnage (Regulatory Measurement System), to a vessel whose keel was laid on or after July 18, 1982 but before July 19, 1994, and which did not subsequently undergo alterations resulting in a change substantially affecting its tonnage as deemed by the Commandant (*i.e., is substantially altered.*)
 - (B) For a foreign flag vessel, these resolutions allow tonnage thresholds in effect on July 18, 1994 to be applied, at the vessel owner's option, using the foreign country's national measurement system tonnage, to a vessel whose keel was laid on or after July 18, 1982, but on or before July 18, 1994, and which did not undergo alterations after July 18, 1994 of a magnitude deemed by that country to constitute a substantial variation in its tonnage subject to the provisions of these resolutions.
 - (iii) Any other international grandfathering provisions as authorized under appropriate International Maritime Organization instruments to which the United States is a party, or which are otherwise recognized or accepted by the United States.
- (2) For all other vessels, apply all tonnage thresholds using Regulatory Measurement System tonnage.

(c) Thresholds Found in Federal Statutes and Regulations

Unless otherwise provided for by law, apply tonnage thresholds in Federal statutes and regulations as follows:

¹ See IMO Resolution A.1073(28) of December 4, 2013, "Recommendation on the Use of National Tonnage in Applying International Conventions".

- (1) For vessels measured under the Convention Measurement System only, apply all thresholds using Convention Measurement System tonnage.
- (2) For vessels measured under the Regulatory Measurement System only, apply all thresholds using Regulatory Measurement System tonnage.
- (3) For all other vessels, apply thresholds in effect before July 19, 1994 using the vessel's Regulatory Measurement System tonnage, and all other thresholds using the vessel's Convention Measurement System tonnage.

(d) Alternate Tonnage Thresholds

46 U.S.C. 14104 authorizes the Coast Guard to establish tonnage thresholds based on the Convention Measurement System as an alternative to tonnage thresholds based on the Regulatory Measurement System. Although 46 U.S.C. 14104 addresses only thresholds in Federal statutes, it does not preclude establishing alternate tonnage thresholds for Federal regulations that currently specify thresholds that were based on the Regulatory Measurement System, where appropriate.

- (1) Alternate tonnage is a regulatory framework established by Pub. L. 104-324, which authorizes the Coast Guard to establish tonnage thresholds based on the Convention Measurement System as an alternative to tonnage thresholds based on the Regulatory Measurement System. Although Pub. L. 104-324 addresses only thresholds in Federal statutes, it does not preclude establishing alternate tonnage thresholds for Federal regulations that currently specify thresholds that were based on the Regulatory Measurement System, where appropriate.
- (2) A vessel regulated to an alternate tonnage threshold established under this part must not be measured under the Regulatory Measurement System.

§ 69.21 RIGHT OF APPEAL

Any person directly affected by a decision or action taken under this part, Coast Guard, by or on behalf of the Coast Guard, may appeal there from in accordance with subpart 1.03 of this chapter

§ 69.23 FEES

Measurement organizations are authorized to charge a fee for measurement services. Information on fees is available directly from the organizations.

§ 69.25 PENALTIES

(a) General violation

The vessel owner, charterer, managing operator, agent, master, and individual in charge of a vessel in violation of a regulation in this part are each liable to the United States Government for a civil penalty of not more than \$30,000. Each day of a continuing violation is a separate violation. The vessel also is liable in rem for the penalty.

(b) False Statements

A person knowingly making a false statement or representation in a matter in which a statement or representation is required by this part is liable to the United States Government for a civil penalty of not more than \$30,000 for each false statement or representation. The vessel also is liable in rem for the penalty.

§ 69.27 DELEGATION OF AUTHORITY TO MEASURE VESSELS

(a) *Statutory Authority*

Under 46 U.S.C. 14103, the Coast Guard is authorized to delegate to a “qualified person” the authority to measure and certify U.S. flag vessels under this part.

(b) *Delegation to Measurement Organizations*

Authority to measure and certify U.S. flag vessels under the Convention Measurement System and Standard and Dual Regulatory Measurement Systems may be delegated to an organization that—

- (1) Is a full member of the International Association of Classification Societies (IACS);
- (2) Is incorporated under the laws of the United States, a State of the United States, or the District of Columbia;
- (3) In lieu of the requirements in paragraphs (b)(1) and (2) of this section, is a recognized classification society under the requirements of 46 CFR part 8.
- (4) Is capable of providing all measurement services under the Convention Measurement System and Standard and Dual Regulatory Measurement Systems for vessels domestically and internationally;
- (5) Maintains a tonnage measurement staff that has practical experience in measuring U.S. flag vessels under the Convention Measurement System and Standard and Dual Regulatory Measurement Systems; and
- (6) Enters into a written agreement, as described in paragraph (d) of this section.

(c) *Applying for Delegation*

Applications for delegation of authority under this section must be forwarded to the Commandant and include the following information on the organization:

- (1) Its name and address.
- (2) Its organizational rules and structure.
- (3) The location of its offices that are available to provide measurement services under the Convention Measurement System and Standard and Dual Regulatory Measurement Systems.
- (4) The name, qualifications, experience, and job title of each full-time or part-time employee or independent contractor specifically designated by the organization to provide measurement services under the Convention Measurement System or Standard or Dual Regulatory Measurement Systems.
- (5) Its tonnage measurement training procedures.

(d) *Written Agreement*

If, after reviewing the application, the Coast Guard determines that the organization is qualified to measure and certify U.S. vessels on behalf of the Coast Guard, the organization must enter into a written agreement with the Coast Guard which—

- (1) Defines the procedures for administering and implementing the tonnage measurement and certification processes, including the roles and responsibilities of each party;

- (2) Outlines the Coast Guard's oversight role;
- (3) Prohibits the organization from using an employee or contractor of the organization to measure and certify the tonnage of a vessel if that employee or contractor is acting or has acted as a tonnage consultant for that same vessel; and
- (4) Requires the organization to—
 - (i) Accept all requests to perform delegated services without discrimination and without regard to the vessel's location, unless prohibited from doing so under the laws of the United States or under the laws of the jurisdiction in which the vessel is located;
 - (ii) Physically inspect each vessel before issuing a tonnage certificate;
 - (iii) Provide the Coast Guard with current schedules of measurement fees and related charges;
 - (iv) Maintain a tonnage measurement file for each U.S. vessel that the organization measures and permit access to the file by any person authorized by the Commandant;
 - (v) Permit observer status representation by the Coast Guard at all formal discussions that may take place between the organization and other vessel tonnage measurement organizations pertaining to tonnage measurement of U.S. vessels or to the systems under which U.S. vessels are measured;
 - (vi) Comply with and apply all laws and regulations relating to tonnage measurement of U.S. vessels within the scope of authority delegated; and
 - (vii) Comply with all other provisions, if any, of the written agreement.

§ 69.28 ACCEPTANCE OF MEASUREMENT BY A FOREIGN COUNTRY

(a) *Convention Measurement System Compliance*

The Commandant must accept the measurement of a foreign flag vessel by a foreign country as complying with subpart B of this part if—

- (1) The vessel was measured under the terms of the Convention and the foreign country is party to the Convention; or
- (2) The Commandant finds that the laws and regulations of that country related to measurement are similar to those of subpart B of this part.

(b) *Regulatory Measurement System Compliance*

The Commandant may accept the measurement of a foreign flag vessel by a foreign country as complying with subpart C, D, or E of this part if the Commandant finds that the laws and regulations of that country related to measurement are substantially similar to those of subpart C, D, or E, respectively, of this part.

§ 69.29 OMB CONTROL NUMBERS ASSIGNED UNDER THE PAPERWORK REDUCTION ACT

(a) Purpose

This section collects and displays the control numbers assigned to information collection and record keeping requirements in this part by the Office of Management and Budget (OMB) pursuant to the Paperwork Reduction Act of 1980 (44 U.S.C. 3501 et seq.). The Coast Guard intends that this part comply with 44 U.S.C. 3507(f), which requires that agencies display the current control number assigned by the Director of OMB for each approved agency information collection requirement.

(b) Display

Section of 46 CFR part 69	Currently assigned OMB control No.
69.17	1625-0022
69.19	1625-0022
69.21	1625-0022
69.27	1625-0022
69.55	1625-0022
69.105	1625-0022
69.121(d)	1625-0022
69.159	1625-0022
69.179	1625-0022
69.205	1625-0022

(Page intentionally left blank)

CONVENTION MEASUREMENT SYSTEM² (46 CFR 69 Subpart B with Interpretations)

§ 69.51 PURPOSE

This subpart prescribes the requirements for measuring a vessel in order to comply with the International Convention on Tonnage Measurement of Ships, 1969 (Convention), and 46 U.S.C. chapter 143.

§ 69.53 DEFINITIONS

As used in this subpart -

AMIDSHIPS means the midpoint of the registered length, as “registered length” is defined in this section.

BOUNDARY BULKHEAD means the bulkhead or partition that separates an enclosed interior space from the surrounding weather. In general, the exterior bulkhead of a deck structure is the boundary bulkhead.

CARGO SPACE means an enclosed space appropriated for the transport of cargo which is to be discharged from the vessel. The term does not include a space which qualifies as an excluded space under § 69.61.

ENCLOSED SPACE is defined in § 69.59.

EXCLUDED SPACE is defined in § 69.61.

LINE OF THE UPPER DECK means a longitudinal line at the underside of the upper deck or, if that deck is stepped, the longitudinal line of the underside of the lowest portion of that deck parallel with the upper portions of that deck.

MOLDED DEPTH means the vertical distance amidships between the following points:

- (a) **Upper Terminus** From the line of the upper deck at the vessel’s side or, if the vessel has rounded gunwales, from the intersection of the line of the upper deck extended to the molded line of the shell plating as though the gunwales were of angular design.
- (b) **Lower Terminus** To the top of the flat *plate* keel, *or equivalent (i.e. to the lower edge of the keel rabbet if the vessel is of wood or composite structure, or to the point where the line of the flat of the bottom extended inward cuts the side of the keel if the vessel’s lower part is hollow or has thick garboards).*

MOLDED DRAFT means -

- (a) **Vessels Assigned Load Line Under Parts 42, 44, 45 or 47** For vessels assigned a load line under parts 42, 44, 45, or 47 of this chapter, the draft corresponding to the Summer Load Line (other than a timber load line).
- (b) **Passenger Vessels Assigned Load Line Under Part 46** For passenger vessels assigned a load line under part 46 of this chapter, the draft corresponding to the deepest subdivision load line assigned;

² Coast Guard interpretations of the International Convention on the Tonnage Measurement of Ships, 1969, are included in Appendix B, and used for related terms (e.g., “registered length” as defined in the tonnage regulations and “length” as defined in Article 2 of the Convention). The Coast Guard also applies International Maritime Organization (IMO) and International Association of Classification Societies (IACS) Unified interpretations contained in this appendix when interpreting both this Convention, and the tonnage regulations, unless otherwise indicated.

- (c) **Other Vessels Assigned Load Line** For vessels to which parts 42, 44, 45, 46, or 47 of this chapter do not apply but which otherwise have been assigned a load line, the draft corresponding to the Summer Load Line so assigned;
- (d) **Vessels Otherwise Restricted in Draft** For vessels to which no load line has been assigned but the draft of which is restricted under any Coast Guard requirement, the maximum draft permitted under the restriction; and
- (e) **All Other Vessels** For other vessels, 75 percent of the molded depth.

PASSENGER means a person on board a vessel other than -

- (a) The master, a member of the crew, or other person employed or engaged in any capacity in the business of the vessel; and
- (b) A child under one year of age.

REGISTERED BREADTH means the maximum breadth of a vessel's *hull* measured **amidships** to the molded line of the frame in a vessel with a metal shell and to the outer surface of the hull in all other vessels.

REGISTERED DEPTH means the molded depth as defined in this section.

REGISTERED LENGTH means either 96 percent of the length on a waterline at 85 percent of the least molded depth measured from the top of the flat *plate* keel or the length from the fore side of the stem to the axis of the rudder stock on that waterline, whichever is greater. In vessels designed with a rake of keel, this length is measured on a waterline parallel to the design waterline.

UPPER DECK means the uppermost complete deck exposed to weather and sea, which has permanent means of weathertight closing of all openings in the weather part of the deck, and below which all openings in the sides of the vessel are fitted with permanent means of watertight closing.

WEATHERTIGHT means secure against penetration of water into the vessel in any sea condition.

§ 69.55 APPLICATION FOR MEASUREMENT

Applications for measurement under this subpart must include the following information and plans:

- (a) Type of vessel
- (b) Vessel's name and official number (if assigned).
- (c) Builder's name and the vessel hull number assigned by *the* builder.
- (d) Place built and delivery date (or scheduled delivery date).
- (e) Date keel was laid.
- (f) Overall length, breadth, and depth of vessel.
- (g) Lines plan.
- (h) Booklet of offsets at stations.
- (i) Capacity plans for tanks and cargo compartments.
- (j) Hydrostatic curves.
- (k) Construction plans showing measurements and scantlings of deck structures, hatches, appendages, recesses, and other enclosed spaces.
- (l) Arrangement plans.

§ 69.57 GROSS TONNAGE ITC

Gross Tonnage ITC (GT ITC) is determined by the following formula $GT\ ITC = K_1 V$, in which V = total volume of all enclosed spaces in cubic meters and $K_1 = 0.2 + 0.02 \log_{10} V$.

§ 69.59 ENCLOSED SPACES

Enclosed space means a space which is bounded by the vessel's hull, by fixed or portable partitions or bulkheads, or by decks or coverings other than permanent or movable awnings. No break in a deck, nor any opening in the vessel's hull, in a deck or in a covering of a space, or in the partitions or bulkheads of a space, nor the absence of a partition or bulkhead precludes the space from being included in the *total volume of all* enclosed spaces (*V*). Portable enclosed spaces, regardless of method of attachment to the vessel, are treated as enclosed spaces as defined in this paragraph.

§ 69.61 EXCLUDED SPACES

(a) *General*

Excluded space means an enclosed space which is excluded from the total volume of all enclosed spaces (*V*) in calculating gross tonnage ITC. Spaces that are below the upper deck and open to the sea, as well as those spaces listed in paragraphs (b) through (f) of this section, are excluded spaces, except as under paragraph (g) of this section.

(b) *Space Opposite End Openings*

A space that is within a *deck* structure and that is opposite an end opening extending from deck to deck (except for a curtain plate of a height not exceeding by more than one inch the depth of the adjoining deck beams) and having a breadth equal to or greater than 90 percent of the breadth of the *deck structure at deck level* at the line of the opening is an excluded space, subject to the following.

- (1) ***Unrestricted End Opening*** Only the space between the actual end opening and a line drawn parallel to the line or *the* face of the opening at a distance from the opening equal to one-half of the breadth of the *deck structure at deck level* at the line of the opening is excluded. (See § 69.75, figure 1.)
- (2) ***Restricted End Opening*** If, because of any arrangement (except convergence of the outside plating as shown in § 69.75, figure 3), the breadth of the space is less than 90 percent of the breadth of the *deck structure at deck level*, only the space between the line of the opening and a parallel line drawn through the point where the athwartship breadth of the space is equal to 90 percent or less of the breadth of the *deck structure at deck level* is excluded. (See § 69.75, figures 2 and 4.)
- (3) ***Excluded Spaces Separated by Open Space*** When any two spaces, either of which is excluded under paragraphs (b)(1) or (b)(2) of this section, are separated by an area that is completely open except for bulwarks or open rails, these two spaces must not be excluded if the separation between the two spaces is less than the least half breadth of the deck in way of the separation. (See § 69.75, figures 5 and 6.)
- (4) ***Determining Breadth of Deck (B)*** When the deck at the line of an opening has rounded gunwales, the breadth of the deck is the distance between the tangent points indicated in § 69.75, figure 11.

(c) *Covered Space Open on Sides*

A space that is open to the weather and that is under an overhead deck covering with no connection on the space's exposed sides between the covering and the deck other than the stanchions necessary for the covering's support is an excluded space. An open rail or bulwark fitted at the vessel's side does not disqualify the space from being an excluded space if the height between the top rail or bulwark and the overhead structure or curtain plate (if fitted) is not less than 2.5 feet or one-third of the height of the space, whichever is greater. (See § 69.75, figure 7.)

(d) Covered Space in Way of Side Openings

A space in a side-to-side *deck* structure directly in way of opposite side openings not less than 2.5 feet in height or one-third of the height of the structure, whichever is greater, is an excluded space. If the opening is only on one side of the *deck* structure, or the space inboard of the opening is bounded by an interior bulkhead or bulkheads, the space to be excluded is limited inboard from the opening to a maximum of one-half the breadth of the deck in way of the opening. (See § 69.75, figure 8.)

(e) Space Below Uncovered Opening

A space in a *deck* structure immediately below an uncovered opening in the deck overhead or that is otherwise open from above is an excluded space, if the opening is exposed to the weather and the space to be excluded is limited to the area of the opening. (See § 69.75, figure 9.)

(f) Recesses

A recess in a *deck* structure which is exposed to the weather and which has an opening that extends from deck to deck without a means of closing is an excluded space, if the interior width of the space is not greater than the width of the opening and extension of the space into the structure is not greater than twice the width of the opening. (See § 69.75, figure 10.)

(g) Additional Restrictions on Excluded Spaces

Any space described in paragraphs (a) through (f) of this section which fulfills at least one of the following conditions is not an excluded space:

- (1) Space Fitted With Means of Securing Cargo or Stores** The space is fitted with shelves or other means designed for securing cargo or stores.
- (2) Opening Fitted With Closure Means** The opening that would otherwise permit the space to be excluded space is fitted with a means of closure.
- (3) Opening Can Otherwise be Closed** Other features of the space make it possible for the space to be closed.

§ 69.63 NET TONNAGE ITC

Net tonnage ITC (NT ITC) is determined by the formula:

$$\text{NT ITC} = K_2 V_c \left(\frac{4d}{3D} \right)^2 + K_3 \left(N_1 + \frac{N_2}{10} \right),$$

in which:

V_c = total volume of cargo spaces in cubic meters.

$$K_2 = 0.2 + 0.02 \log_{10} V_c$$

$$K_3 = 1.25 \left(\frac{\text{GT ITC} + 10,000}{10,000} \right)$$

D = molded depth amidships in meters, as "molded depth" is defined in § 69.53.

d = molded draft amidships in meters, as "molded draft" is defined in § 69.53.

N_1 = number of passengers in cabins with not more than eight berths, as "passenger" is defined in § 69.53.

N_2 = number of other passengers, as "passenger" is defined in § 69.53.

GT ITC = gross tonnage ITC as determined under § 69.57.

N_1 plus N_2 must equal the total number of passengers the vessel is permitted to carry as indicated on the ship's Passenger Certificate. If N_1 plus N_2 is less than 13, both N_1 and N_2 are zero.

$\left(\frac{4d}{3D} \right)^2$ must not be greater than unity.

$K_2 V_c \left(\frac{4d}{3D} \right)^2$ must not be less than 0.25 GT ITC.

NT ITC must not be less than 0.30 GT ITC.

§ 69.65 CALCULATION OF VOLUMES

(a) *Naval Architectural Practices*

Volumes V and V_c used in calculating gross tonnage ITC and net tonnage ITC, respectively, must be measured and calculated according to accepted naval architectural practices for the spaces concerned. *Regardless of the methods used, calculated volumes should be within approximately 1% of as-built volumes, unless otherwise specified or authorized. Observe the following:*

(1) *Simple Geometric Shapes* *In general, exact mathematical formulae are used to calculate volumes of structures having simple geometric shapes of standard form.*

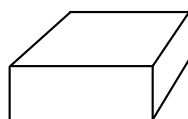

$$V = LBD$$

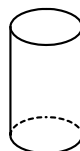

$$V = \pi r^2 L$$



$$V = 4\pi r^3/6$$

(2) **Complex Geometric Shapes** In general, numerical integration methods are used to calculate volumes of complex or non-standard geometric shapes. These may be referred to as “two-dimensional” and “three-dimensional” integration methods.

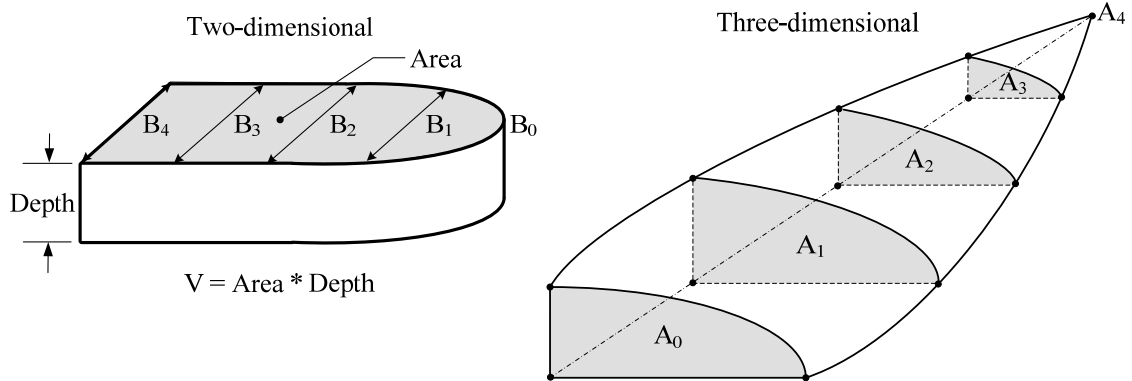

(3) **Limitations on Integration Methods** Any appropriate integration method may be used, provided it yields sufficiently accurate results. In naval architecture, traditionally Simpson’s first rule and the trapezoidal rule have been used in volume calculations, as follows:

(i) **Simpson’s First Rule** This method is used to approximate areas bounded by curves. Divide a given area to be evaluated into n sections (where n is an even number) by means of $n + 1$ parallel lines, called ordinates, drawn at a constant distance h apart. Denote the lengths of these ordinates by y_0, y_1, \dots, y_n . (Note that y_0 or y_n may be zero.) The area is calculated as $A \approx h/3 (y_0 + 4y_1 + 2y_2 + 4y_3 + 2y_4 + \dots + 2y_{n-2} + 4y_{n-1} + y_n)$. The greater the number of divisions, the more accurate the result. In general, the ends of each area to be evaluated should coincide with chines, breaks, steps, knuckles, and similar discontinuities. Simpson’s rule may be applied to calculating volumes, if the ordinates (y_0, y_1, \dots) are interpreted as the areas of plane sections (A_0, A_1, \dots), at constant distance h apart.

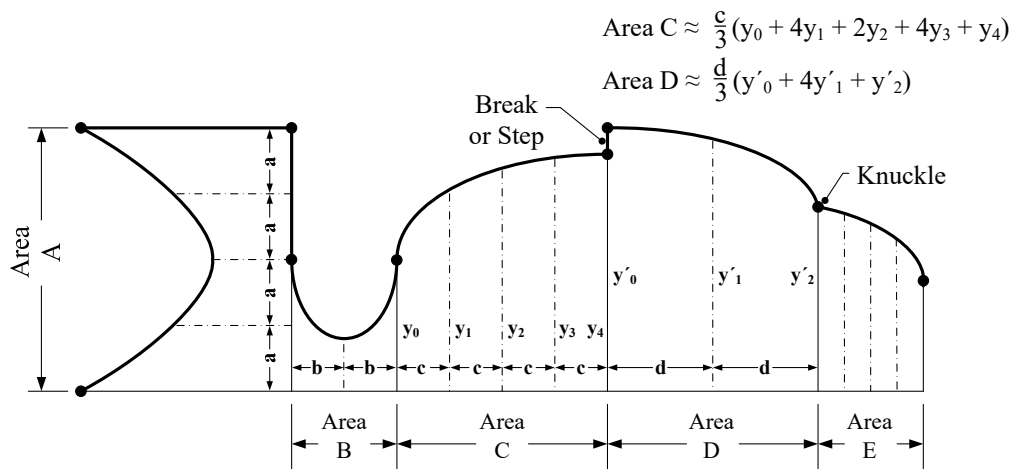

(ii) **Trapezoidal Rule** This method can be used with any number of sections (even or odd). Divide a given area to be evaluated into n sections (where n need not be an even number) by means of $n + 1$ parallel lines, called ordinates, drawn at a constant distance h apart. Denote the lengths of these ordinates by y_0, y_1, \dots, y_n . (Note that y_0 or y_n may be zero.) The area is calculated as $A \approx h (y_0/2 + y_1 + y_2 + y_3 + y_4 + \dots + y_{n-1} + y_n/2)$. The greater the number of divisions, the more accurate the result. Smaller intervals relative to those used under Simpson's first rule are generally necessary to provide sufficient accuracy.

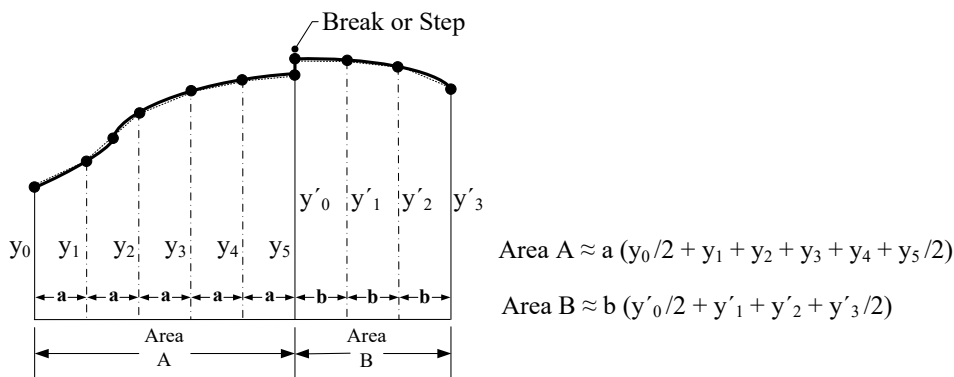

(4) **Linear Structures Less Than 1 m² in Area** The volumes of linear appendages, masts and similar (e.g., hollow skegs, bilge keels, deckhouse overhangs and cockpit coamings) may be calculated by multiplying an average (approximate) sectional area by an average (approximate) length, provided the average sectional area of the appendage is less than one square meter.

(b) **Termination of Measurements**

Measurements must be taken regardless of the fitting of insulation or the like, to the inner side of the shell of the hull (or to the inner side of the structural boundary plating for deck structures) in vessels constructed of metal, and to the outer surface of the shell of the hull (or to the inner side of the structural boundary surfaces for deck structures) in all other vessels. If the deck structure has framing, dimensions are taken to the inner surface of the skin.

§ 69.67 MARKING OF CARGO SPACES

Cargo spaces used in determining volume (V_c) for calculating net tonnage must be permanently marked with the letters "CC" (cargo compartment) which are at least four inches in height and positioned so as to be visible at all times. The methods for marking described in § 69.119(p)(3) are considered to fulfill the requirements of this section for permanent marking.

§ 69.69 TONNAGE CERTIFICATE

(a) **International Tonnage Certificate (1969)**

On request of the vessel owner, the authorized measurement organization must issue an International Tonnage Certificate (1969) as evidence of the vessel's measurement under this subpart for a vessel that is 24 meters (79.0 feet) or more in registered length, will engage on a foreign voyage, and is not a vessel of war. The Certificate is delivered to the vessel owner or master and must be maintained on board the vessel when it is engaged on a foreign voyage. For a vessel for which a remeasurement under § 69.71 resulted in a net tonnage ITC decrease due to changes other than alterations or modifications to the vessel deemed by the Commandant to be of a major character, an International Tonnage Certificate (1969) reflecting the decreased net tonnage ITC will not be reissued until 12 months have elapsed from the date of measurement indicated on the current certificate.

(b) *U.S. Tonnage Certificate*

If an International Tonnage Certificate (1969) is not issued for a vessel measured under this part, the measurement organization must issue a U.S. Tonnage Certificate as evidence of the vessel's measurement under this subpart, which must also indicate the vessel's measurement under any other subpart of this part. There is no requirement to maintain the U.S. Tonnage Certificate on board the vessel.

(c) *Flag Transfer*

For a vessel that transfers flag to a foreign country that is party to the Convention, the International Tonnage Certificate (1969) remains valid for a period not to exceed 3 months after the flag transfer, or until an International Tonnage Certificate (1969) is issued under authority of the foreign country to replace it, whichever is earlier.

§ 69.71 CHANGE OF NET TONNAGE

(a) *Net Tonnage Increases*

When a vessel is altered so that the net tonnage is increased, the new net tonnage must be applied immediately.

(b) *Vessel With Different Load Line Assignments*

A vessel concurrently assigned load lines under both the International Convention on Load Lines (parts 42, 44, 45, or 47 of this chapter) and either the International Convention for the Safety of Life at Sea (SOLAS) (part 46 or 47 of this chapter) or other international agreement must be assigned only one net tonnage. The net tonnage assigned must be the net tonnage applicable to the load line assigned under the International Convention on Load Lines, SOLAS or other international agreement for the trade in which the vessel is engaged.

(c) *Net Tonnage Decreases*

When a vessel is altered so that the net tonnage is decreased or the vessel's trade is changed so that the load line assigned for that trade under paragraph (b) of this section is no longer appropriate and results in a decrease in its net tonnage, a new International Tonnage Certificate (1969) incorporating that net tonnage may not be issued until twelve months after the date on which the current Certificate was issued. However, if one of the following apply, a new Certificate may be issued immediately:

- (1) The vessel is transferred to the flag of another nation.
- (2) The vessel undergoes alterations or modifications which the Commandant deems to be of a major character, such as the removal of a superstructure which requires an alteration of the assigned load line.

§ 69.73 TREATMENT OF NOVEL TYPE VESSELS

(a) *Novel Vessel Determinations*

When application of this subpart to a novel type vessel produces unreasonable or impractical results, the Commandant may determine a more suitable method of measurement.

(b) *Submittal of Determination Requests*

Requests for a determination must be submitted to the Commandant, explaining the reasons for seeking a determination, and including a description of the spaces in question, if applicable.

§ 69.75 FIGURES

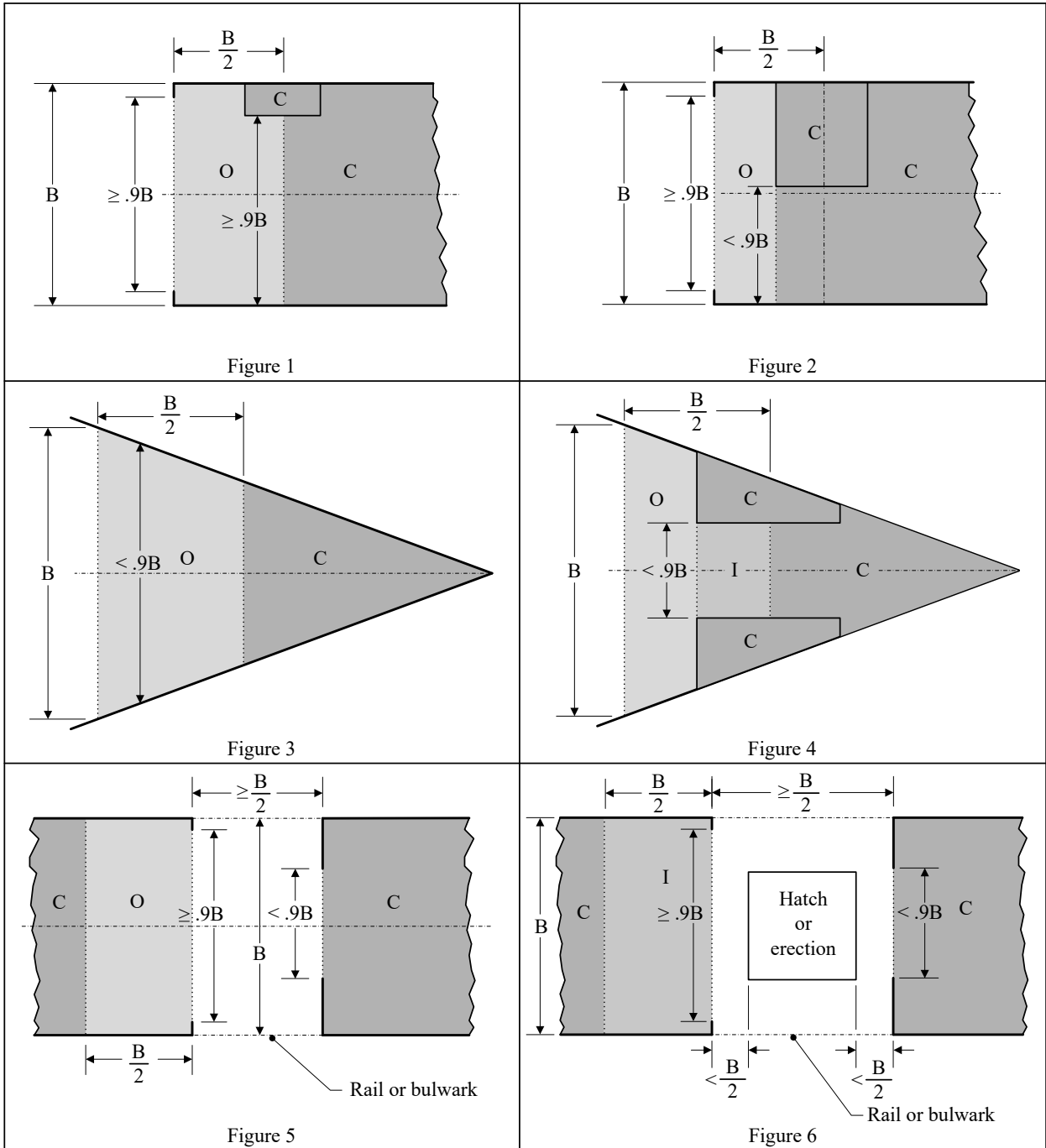

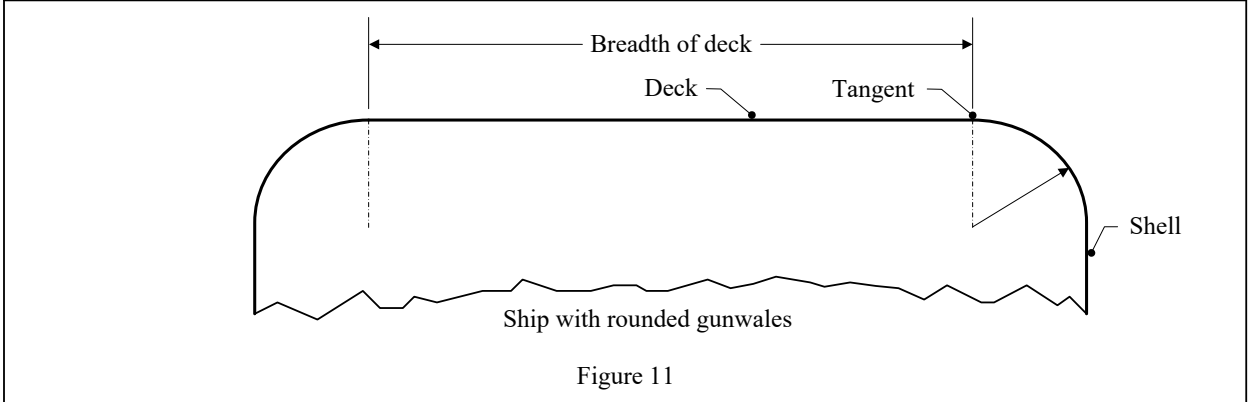
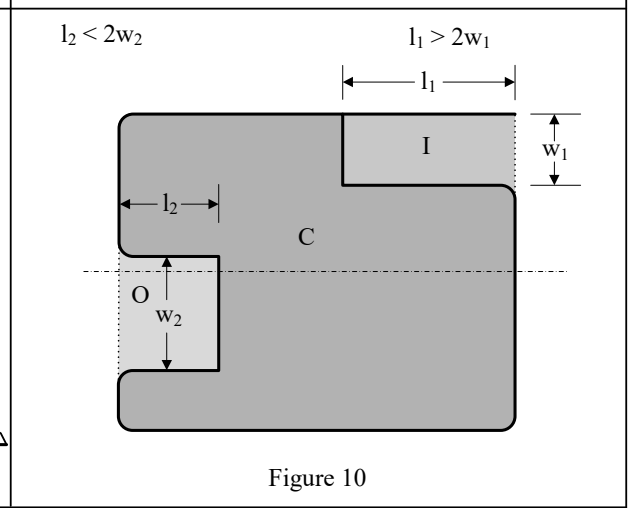
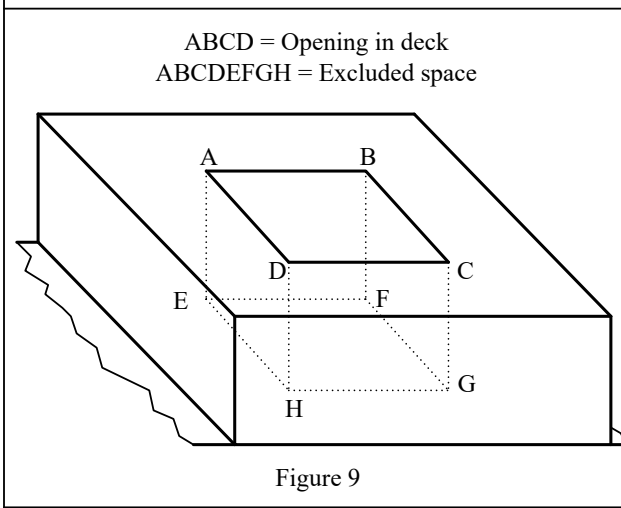
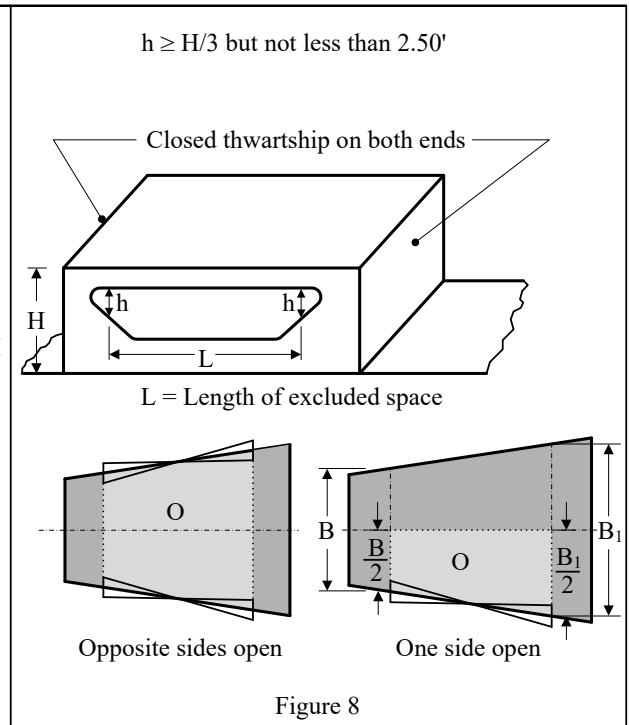
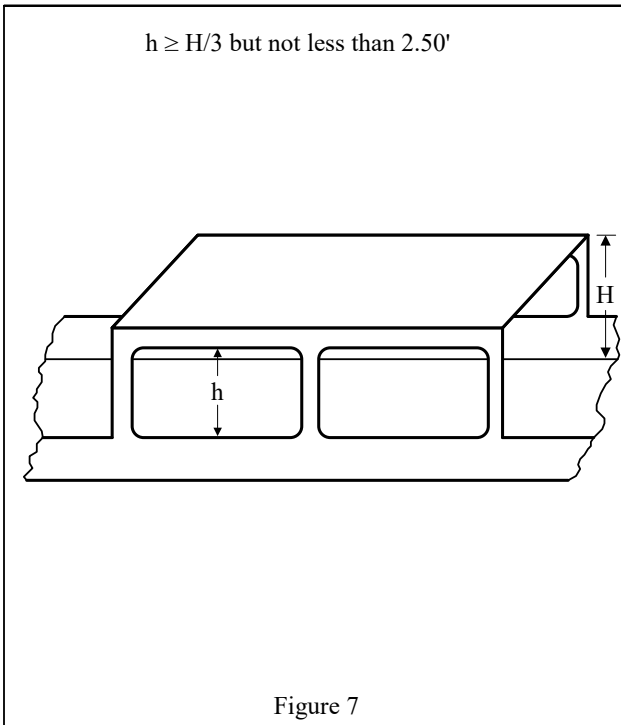

STANDARD REGULATORY MEASUREMENT SYSTEM (46 CFR 69 SUBPART C with Interpretations)

§ 69.101 PURPOSE

This subpart prescribes the procedures for measuring a vessel under the Standard Regulatory Measurement System described in 46 U.S.C. 14512. *Except as otherwise provided in this subpart, measurement precision and treatment of volumes of enclosed spaces not exceeding one cubic meter in volume is as provided for under the Convention Measurement System (46 CFR 69 subpart B).*

§ 69.103 DEFINITIONS

As used in this subpart -

BETWEEN-DECK means the space above the line of the tonnage deck and below the line of the *uppermost complete deck*. The term “between-deck” is also used to refer to the space between enumerated decks that are above the tonnage deck, such as the space between the tonnage deck and the next enumerated deck above. Refer to § 69.109(d) for requirements on enumerated decks.

BREAK means the space between the line of a deck and the upper portion of that deck, in cases where that deck is stepped and continued at a higher elevation.

CAMBER means the perpendicular rise or crown of a deck at the centerline of the vessel measured above the skin of the vessel at the vessel’s sides.

CEILING means the permanent planking or plating fitted directly on the inboard side of frames, floors, or double bottom and includes cargo battens and refrigeration insulation but does not include false ceiling which stands off from the framing.

COAMING means both the vertical plating around a hatch or skylight and the sill below an opening in a bulkhead.

DECKHOUSE means a structure that is on or above the uppermost complete deck and that does not extend from side to side of the vessel. The term includes cabin trunks and closed-in spaces over the holds of vessels.

DEPTH OF FRAME means the perpendicular depth of a bottom frame and the athwart distance between the inboard and outboard faces of a side frame.

DOUBLE BOTTOM means a space at the bottom of a vessel between the inner and outer bottom plating, used solely for water ballast.

DOUBLE BOTTOM FOR WATER BALLAST means a space at the bottom of a vessel between the inner and outer bottom plating, used solely for water ballast. *For the space to be considered a double bottom for water ballast, the inner bottom plating must be completely watertight (except for openings to contiguous tanks that are above) and extend continuously fore and aft (interrupted only by peak tanks, cofferdams, and engine rooms) and transversely from one side of the vessel’s hull to the other. All accesses to the double bottom for water ballast must also be watertight.*

FLOOR means a vertical plate or timber extending from bilge to bilge in the bottom of a vessel. In a wooden vessel, “floor” means the lowermost timber connecting the main frames at the keel when that timber extends the full depth of the frames to which it is fastened. In a double bottom, floors usually extend from the outer to the inner bottom.

GROSS REGISTER TONNAGE is defined in § 69.107(a).

HATCH means an opening in a deck through which cargo is laden or discharged.

LINE OF THE NORMAL FRAMES means the imaginary horizontal line that connects the inboard faces of the smallest normal frames.

LINE OF THE ORDINARY FRAMES means the line of intersection of the imaginary surface or surfaces tangent to the inboard faces of the ordinary frames (or the inside of the vessel's skin, if there are no ordinary frames), and the imaginary plane running transversely through the vessel at the tonnage station of interest. *This line is taken following adjustments as set forth in § 69.109(p) and (q). The line established before such restrictions are applied is referred to as the unadjusted line of the ordinary frames. The imaginary surface is derived by using flat surfaces to connect the centerlines of the frame faces.*

LINE OF THE TONNAGE DECK means the line determined under § 69.109(e).

LINE OF THE UPPERMOST COMPLETE DECK means the line determined under § 69.111(b).

NET REGISTER TONNAGE is defined in § 69.107(b).

NORMAL FRAME means a frame, regardless of size, used to stiffen a structure.

ORDINARY FRAME means a primary side or bottom frame or floor used for strengthening the hull.

REGISTERED BREADTH is defined in § 69.53.

REGISTERED DEPTH means "molded depth" as defined in § 69.53.

REGISTERED LENGTH is defined in § 69.53.

SHELTER DECK means the uppermost deck that would have qualified as the uppermost complete deck had it not been fitted with a middle line opening.

STEP means a cutoff in a deck or in the bottom, top, or sides of a space resulting in varying heights of a deck or varying heights or widths of a space.

SUPERSTRUCTURE means all permanently closed-in structures, including all portable enclosed spaces, on or above the line of the uppermost complete deck or, if the vessel has a shelter deck, on or above the line of the shelter deck. Examples of superstructure spaces include forecastles, bridges, poops, deckhouses, breaks, portable tanks, and modular quarters units.

TONNAGE DECK is defined in § 69.109(c).

TONNAGE INTERVAL means the longitudinal distance between transverse sections of a vessel's under-deck, between-deck, or superstructure when divided into an even number of equal parts for purposes of volume integration.

TONNAGE LENGTH is defined in § 69.109(f).

TONNAGE STATION means the longitudinal location of each transverse section where breadth and depth measurements are taken when calculating under-deck volumes under this subpart. Tonnage stations are numbered consecutively from fore to aft, beginning with the number one.

UPPERMOST COMPLETE DECK is defined in § 69.108.

ZONE OF INFLUENCE METHOD means a Simpson's first rule integration method for determining volumes of under-deck spaces that limits the sectional areas associated with these spaces to the sectional areas at adjacent under-deck tonnage stations, depending on their proximity to those stations. For stations for which the under-deck sectional areas are multiplied by four, the zone of influence extends two-thirds of a tonnage interval on either side of the under-deck station, and for the remaining stations, the zone of influence extends one-third of a tonnage interval on either side of the station.

§ 69.105 APPLICATION FOR MEASUREMENT SERVICES

Applications for measurement services under this subpart must include the following information and plans:

- (a) Type of vessel.
- (b) Vessel's name and official number (if assigned).
- (c) Builder's name and the vessel hull number assigned by the builder.
- (d) Place built and delivery date (or scheduled delivery date).
- (e) Date keel was laid.
- (f) Overall length, breadth, and depth of vessel.
- (g) Lines plan.
- (h) Booklet of offsets.
- (i) Capacity plans for tanks.
- (j) Construction plans showing measurements and scantlings of hull and superstructure.
- (k) Tonnage drawing showing tonnage length in profile and tonnage sections.
- (l) Arrangement plans.

§ 69.107 GROSS AND NET REGISTER TONNAGE

(a) Gross Register Tonnage

The vessel's gross register tonnage is the sum of the following tonnages, less certain spaces exempt under § 69.117:

- (1) Under-deck tonnage (§ 69.109).
- (2) Between-deck tonnage (§ 69.111).
- (3) Superstructure tonnage (§ 69.113).
- (4) Excess hatchway tonnage (§ 69.115(c)).
- (5) Tonnage of framed-in propelling machinery spaces included in calculating gross tonnage (§ 69.121(d)(1)).

(b) Net Register Tonnage

The vessel's net register tonnage is gross register tonnage less deductions under §§ 69.119 and 69.121.

(c) U.S. Tonnage Certificate

The authorized measurement organization must issue a U.S. Tonnage Certificate as evidence of a vessel's measurement under this subpart, which must also indicate the vessel's measurement under the Convention Measurement System in subpart B of this part, if applicable. There is no requirement to maintain the U.S. Tonnage Certificate on board the vessel.

§ 69.108 UPPERMOST COMPLETE DECK

(a) Defined

"Uppermost complete deck" means the uppermost deck which extends from stem to stern and from side to side at all points of its length and is bounded by the vessel's hull.

(b) Restrictions

The uppermost complete deck must not:

- (1) Extend above any space exempted as open space under paragraph (d) of § 69.117;
- (2) Extend below the design waterline, except in the case of vessels such as submersibles, where the entire uppermost complete deck is submerged during normal operations; or
- (3) Rest directly on consecutive or alternating ordinary bottom frames or floors ("ceiling on floors") for a distance of over one-half of the tonnage length. *If the "ceiling on floors" are not contiguous, this criterion is applied using the cumulative (aggregate) distance.*

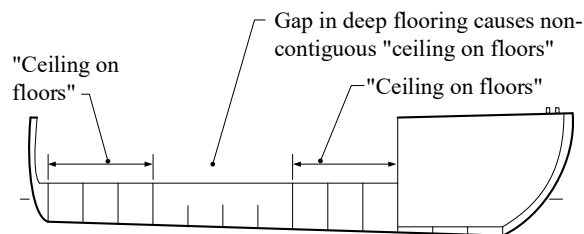
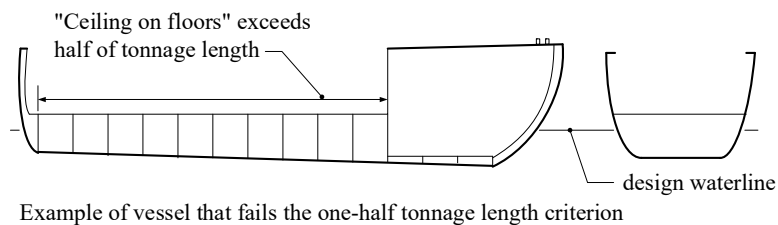
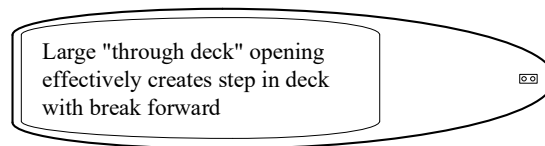

Example of vessel that meets the one-half tonnage length criterion

(c) **Deck discontinuities**

Decking athwartships of the following deck discontinuities is not considered to be part of the uppermost complete deck:

- (1) **Large Through-Deck Openings** Through-deck openings that are not protected from the sea and the weather, such as would be provided by hatch covers or a surrounding superstructure that encloses the opening and whose area is more than 10 percent of the total deck area from stem to stern as viewed from above.
- (2) **Middle Line Openings** Middle line openings conforming to the requirements of § 69.117(e)(2).
- (3) **Large Deck Recesses** Deck recesses that are not through-hull (*e.g.*, cockpits and swimming pools) for which the depth of the deck recess at its deepest point is more than five feet below adjacent portions of the deck, and whose area (as viewed from above) is more than 10 percent of the total deck area from stem to stern, as viewed from above.
- (4) **Wrap-Around Notches** Notches bounded by a deck below that wrap around from the ends to the sides of the vessel for which the depth at the deepest point is more than five feet below adjacent portions of the deck, the area is more than one percent of the total deck area from stem to stern as viewed from above, the length of the notch in the direction of the vessel's longitudinal axis exceeds 10 feet at any point across its width, and the width of the notch in the direction of the vessel's longitudinal axis exceeds two feet at any point along its length.

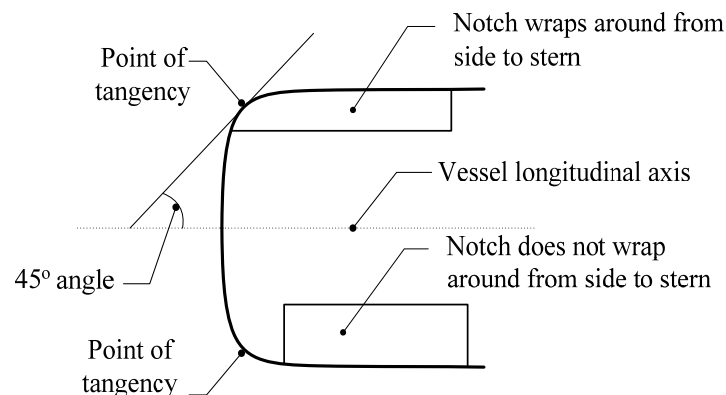

§ 69.109 UNDER-DECK TONNAGE

(a) **Defined**

“Under-deck tonnage” means the tonnage of the space below the line of the tonnage deck, as that volume is calculated under this section.

(b) **Method of Calculating Tonnage**

Under-deck tonnage is calculated by applying Simpson's first rule using the tonnage length and the areas of the transverse sections prescribed by this section.

(c) **Identifying the Tonnage Deck**

In vessels with two or less enumerated decks, the tonnage deck is the uppermost complete deck. In vessels with more than two enumerated decks, the tonnage deck is the second enumerated deck from the keel (*i.e.*, exclusive of any deck that rests directly on bottom frames or floors) as determined in paragraph (d) of this section.

(d) Enumerating the Decks to Identify the Second Deck from the Keel

The uppermost complete deck is an enumerated deck. Decks below the uppermost complete deck that extend from stem to stern and side to side at all points along their lengths are also enumerated, provided they are not disqualified by either of the following deck discontinuities:

- (1) **Through-Deck Opening** A through-deck opening that is not fitted with a cover (or equivalent) and whose area is more than 10 percent of the total deck area, as viewed from above.
- (2) **Deck Recess** A deck recess that is not through-hull for which the depth of the deck recess at its deepest point is more than five feet below adjacent portions of the deck and whose area (as viewed from above) is more than 10 percent of the total deck area from stem to stern, as viewed from above.

(e) Identifying the Line of the Tonnage Deck

In vessels without an enumerated deck, establish the line of the tonnage deck in accordance with § 69.109(o). In vessels with one or two enumerated decks, the line of the tonnage deck is the line of the uppermost complete deck, and is established in accordance with § 69.111(b). In vessels with more than two enumerated decks, establish the line of the tonnage deck as indicated below.

- (1) **Deck Runs in Continuous Line Longitudinally** If the tonnage deck runs in a continuous line from stem to stern, the line of the tonnage deck is the longitudinal line at the underside of the tonnage deck.
- (2) **Deck Runs at Different Levels Longitudinally** If the tonnage deck is stepped, the line of the tonnage deck is the longitudinal line of the underside of the lowest portion of that deck parallel with the upper portions of that deck. Steps that do not extend from side to side or are less than three feet in length are ignored when establishing the line of the tonnage deck. (See § 69.123, figures 1 and 2). Spaces between the line of the tonnage deck and the higher portions of that deck are not included in under-deck tonnage.

(f) Tonnage Length

- (1) **General** “Tonnage Length” means the length of a horizontal straight line measured at the centerline of the vessel from the point forward where the line of the tonnage deck intersects the line of the inboard faces of the ordinary side frames to the point aft where the line of the tonnage deck intersects the inboard face of the ordinary transom frames or cant frames. (See § 69.123, figure 3.)

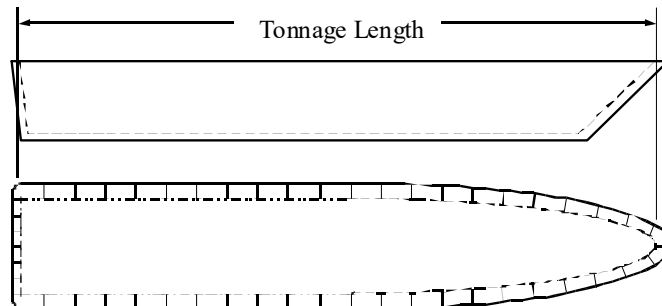

The following additional requirements apply:

- (i) Complex Stem / Stern Geometries For vessels with complex hull geometries at the extreme ends (e.g., SWATHs, monohulls with bulbous bows, etc.), the tonnage length is terminated on an imaginary plane that is perpendicular to the longitudinal axis of the vessel and tangent to the imaginary surface bounding the inboard faces of the ordinary frames at the extreme fore and aft location of this surface.

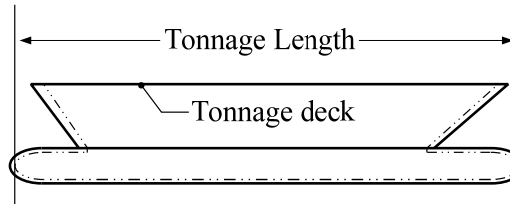

- (ii) “Deep Framed” Sections If the last two ordinary side frames (or alternating ordinary side frames) at the bow/stern of the vessel are solid side-to-side “deep” frames (no sectional area), then the tonnage length is terminated at the location where the vertical plane on the longitudinal axis of the vessel intersects the imaginary surface that is tangent to the inboard faces of the ordinary stem, stern or cant frames at the line of the tonnage deck. In the absence of ordinary stem, stern or cant frames, the tonnage length is terminated on the inside of the vessel’s skin at the extreme end of the vessel.

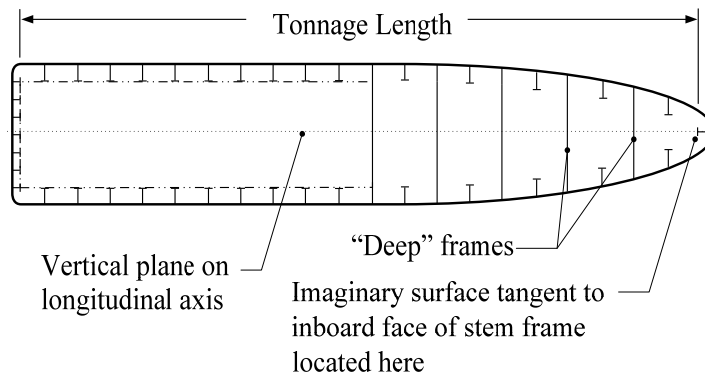

- (2) **Vessel With Headblock or Square End** For a vessel having a headblock or square end with framing which extends from the tonnage deck to the bottom of the vessel, the tonnage length terminates on the inboard face of the headblock or *line of the ordinary end frames*. (See § 69.123, figure 4.)

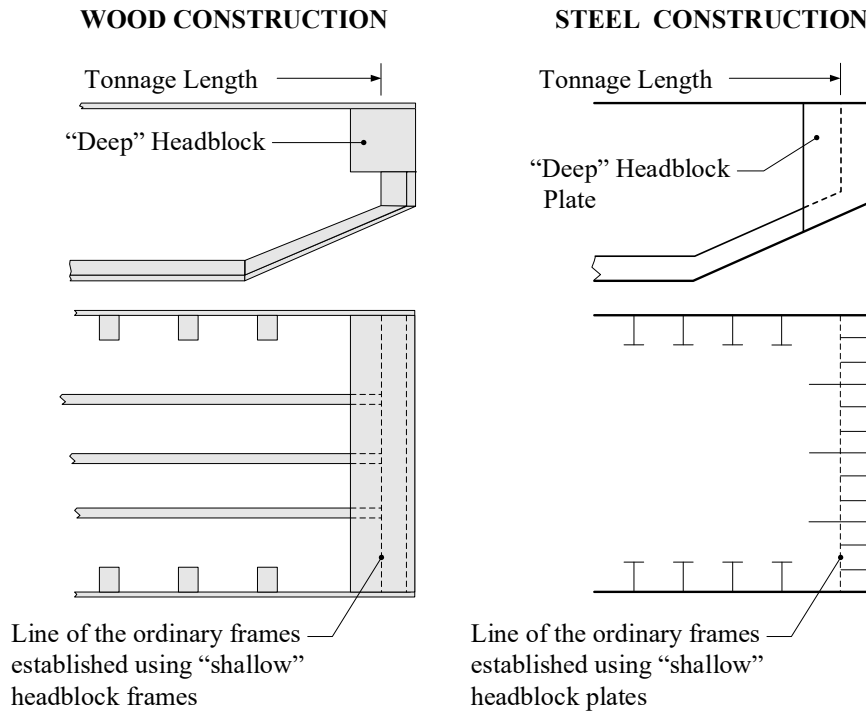

- (3) **Camber** For a vessel having a square bow or stern and tonnage deck with camber, the effect of the camber on the tonnage length must be considered. The tonnage length must be measured below the tonnage deck at a distance equal to one-third of round camber and one-half of straight pitch camber.

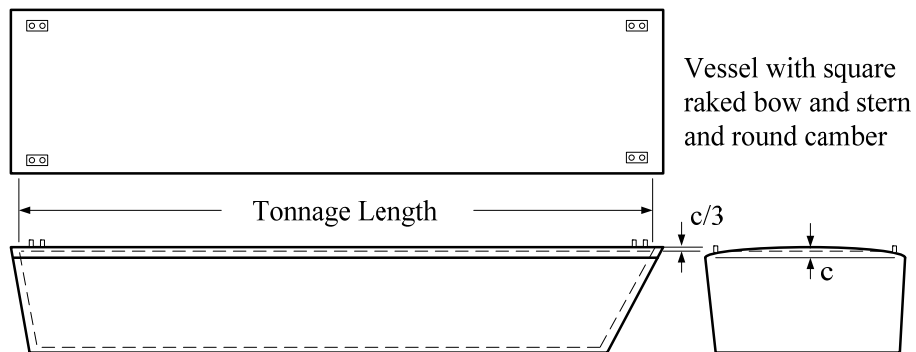

(4) **Restrictions on Termination Points** The forward and after termini of the tonnage length must be a distance of no more than eight and one-half feet from the associated inboard surface of the skin of the hull at the bow and stern as measured at the centerline of the vessel, and the after terminus must not be forward of the centerline of the rudderstock.

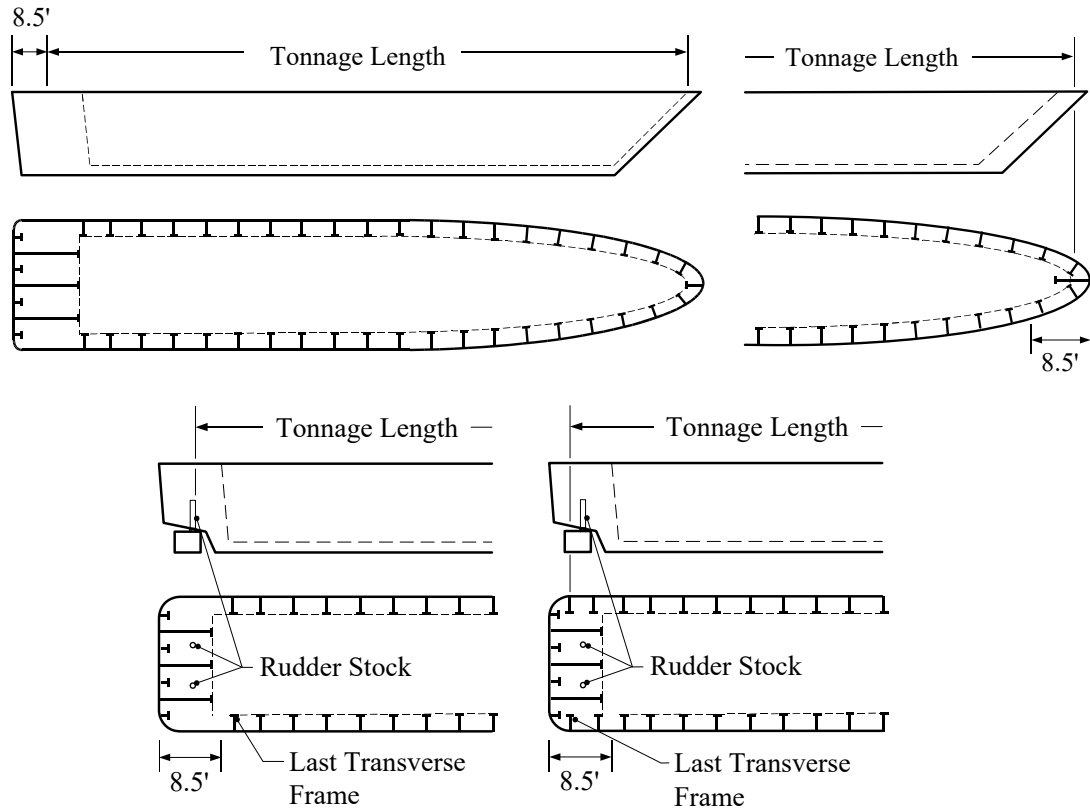

(g) **Division of Vessel into Transverse Sections**

(1) **Number of Divisions** Except as under paragraph (m)(1)(iii) of this section, the tonnage length is divided into an even number of equal parts as indicated in the following table:

Class	Tonnage length	Divisions
1	50 ft. or less	6
2	Over 50 ft. but not exceeding 100 ft	8
3	Over 100 ft. but not exceeding 150 ft	10
4	Over 150 ft. but not exceeding 200 ft	12
5	Over 200 ft. but not exceeding 250 ft	14
6	Over 250 ft.	16

(2) **Location of Stations** Transverse sections are cut at each end of the tonnage length and at each point of division of the tonnage length, whose location is referred to as a tonnage station, and assigned sequential tonnage station numbers, beginning at the stem. Intervals and one-third intervals (described in paragraph (k)(5) of this section) between the points of division are measured to the nearest thousandth of a foot. (See § 69.123 figures 5 and 6.)

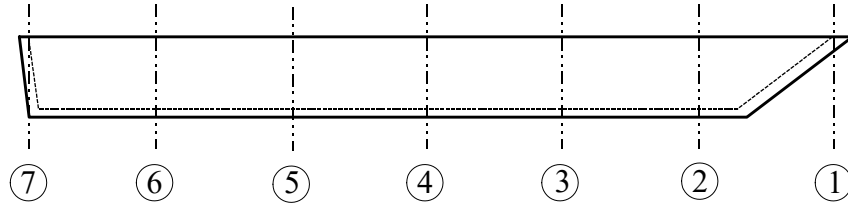

(h) **Depths of Transverse Sections** (see also § 69.109(p) and (q))

(1) **General** Transverse section depths are measured at each point of division of the tonnage length at the centerline of the vessel from a point below the line of the tonnage deck equal to one-third of the camber or to one-half of the pitch of the beam down to the lowest portion of the upper side of the ordinary frames, floors, longitudinals, or tank top of a double bottom for water ballast, as the case may be. Floors and longitudinals in this context are specific types of ordinary frames. If no frames qualify as ordinary frames, depths are terminated at the inner surface of the hull shell.

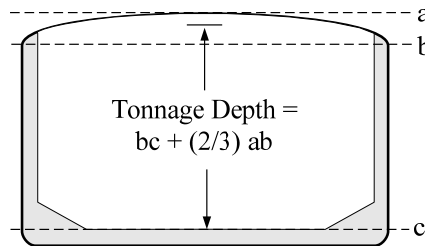

(2) **Tank Top Fall** When a depth falls at a point where the tank top of a double bottom for water ballast has a straight fall from centerline to the wings, the depth terminates at one-half of the height of fall. (See § 69.123 figure 8.)

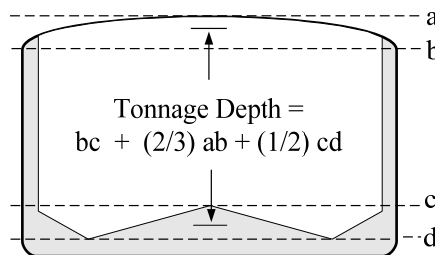

- (3) **Tank Top Rise** When a depth falls at a point where the tank top of a double bottom for water ballast rises from the centerline to the wings, the depth terminates at one-half the dead rise. (See § 69.123, figure 9.)

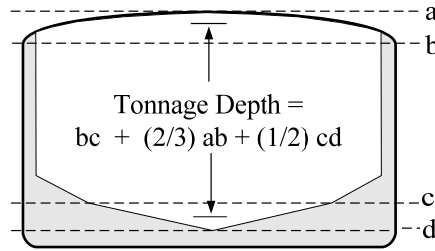

- (4) **Number of Depth Increments** The depth at the midpoint of the tonnage length or, when a vessel is measured in parts, the depth at the midpoint of each part determines the number of equal parts into which each depth is divided, as follows:

- (i) **Midpoint Depth Criterion** If the midpoint depth is 16 feet or less, each depth is divided into four equal parts. If the midpoint depth exceeds 16 feet, each depth is divided into six equal parts. (See § 69.123, figure 7.)

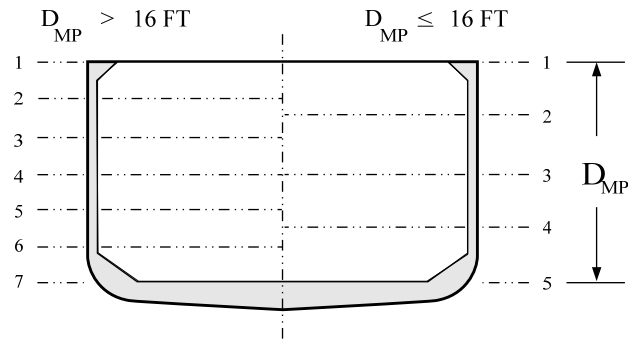

- (ii) **Rounding** The interval between the points of division of a depth and one-third intervals are carried to the nearest hundredth of a foot.

(i) **Breadths of Transverse Sections** (see also § 69.109(p) and (q))

- (1) **General** Transverse section breadths are measured horizontally at each point of division of each depth and also at the upper and lower points of each depth. Breadths are measured to the inboard face of the ordinary frames or to the line of the ordinary frames. Breadths are measured parallel to each other and at right angles to the vessel's centerline. (See § 69.123, figure 7.)

Transversely Framed Vessel

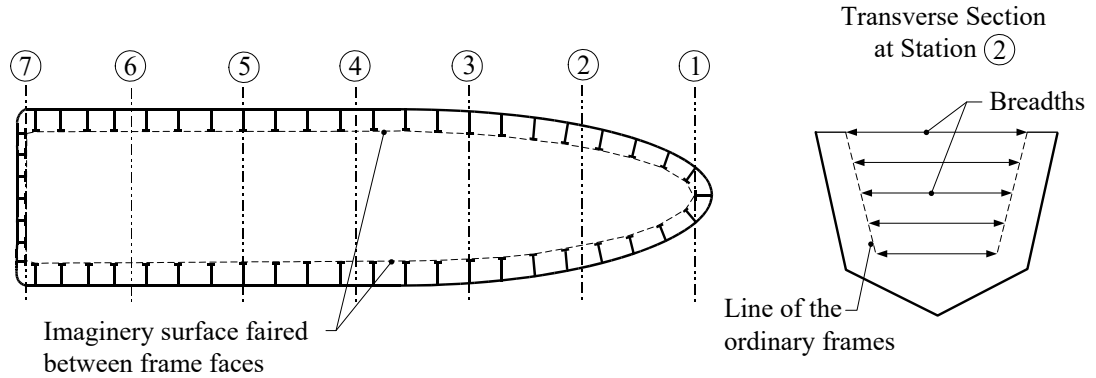

Longitudinally Framed Vessel

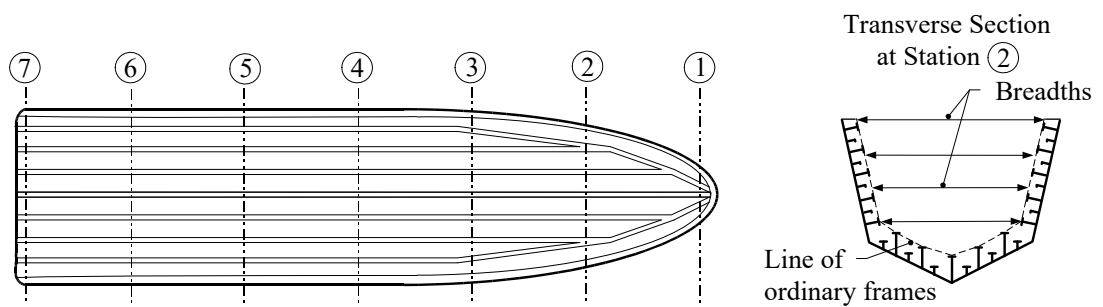

- (2) **Deck Brackets and Camber** Upper breadths are not reduced by measuring to deck-beam brackets. In cases of camber where an upper breadth passes through the deck (see § 69.123, figure 7), the breadth is measured to the line of the side frames at the underside of the deck projected vertically up to the height of the upper breadth.

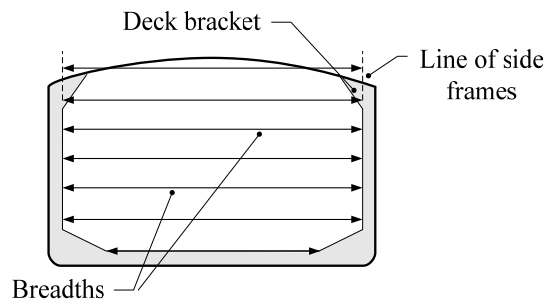

- (3) **Dead Rise** Bottom breadths are measured only as far as the flat of the floor extends. (See § 69.123, figures 7 and 10.) When bottom frames rise immediately from the flat keel, bottom breadths are equal to the breadth of the flat keel. Where there is no double bottom for water ballast and where there is dead rise of the bottom out to the sides of the vessel, bottom breadths are equal to the part of the bottom plating not affected by dead rise.

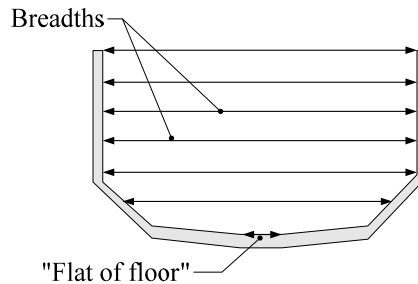

- (4) **Sloping Double Bottom for Water Ballast** Bottom breadths falling in way of a double bottom for water ballast, the top of which rises or falls from centerline to the wings, are measured between the inboard faces of the frame brackets which connect the double bottom for water ballast with the frames. (See § 69.123, figures 8 and 9.)

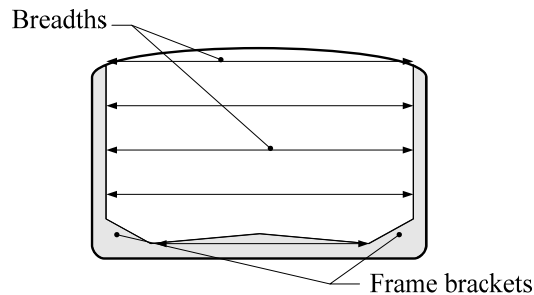

(j) **Measuring Spaces Having Ceiling**

The maximum allowance for terminating measurements on ceiling is three inches on the bottom frames or tank top and three inches on each side frame. When ceiling is less than three inches thick, only the actual thickness is allowed. When ceiling is fitted on a platform directly above the bottom frames, depths are measured down through the platform to the upper side of the frames and the allowable ceiling on the platform is then deducted.

(k) **Area of Transverse Sections**

Areas at each transverse section are calculated as follows:

- (1) **Areas at Extremities of Tonnage Length** A transverse station at the end of the tonnage length may not yield area, except in vessels (such as barges) with an upright bow or stern.
- (2) **Numbering of Breadths** The breadths of each transverse section are numbered from above, the upper being "1", the second down being "2", and so on to the lowest.
- (3) **Applying Multiplication Factors** Multiply the even numbered breadths by four and the odd numbered breadths by two, except for the first and last breadths, which are multiplied by one.
- (4) **Summing Products** Add together the products from paragraph (k)(3) of this section.
- (5) **Final Area Calculations** Multiply the sum from paragraph (k)(4) of this section by one-third of the interval between the breadths. The product is the area of the transverse section.

(l) Calculating Tonnage From Sectional Areas

The total under-deck volume and tonnage is calculated as follows, using the areas determined in paragraph (k)(5) of this section:

- (1) Numbering Stations** Number the transverse sections successively “1”, “2”, and so forth, beginning at the bow.
- (2) Applying Simpson’s Multipliers** Multiply the area of the even numbered sections by four and the area of the odd numbered sections by two, except the first and last sections, which are multiplied by one.
- (3) Completing Volume Calculations** Add together the products from paragraph (1)(2) of this section and multiply the sum by one-third of the interval between the sections. The product is the volume under-deck.
- (4) Converting to Tonnage** The volume under-deck is divided by 100 and is, subject to exemptions, the under-deck tonnage.

(m) Steps in Double Bottom for Water Ballast

This section provides general requirements for measurement “in parts” of vessels of monohull shape having stepped double bottoms for water ballast) where the height of the step(s) exceeds six inches.

- (1) Division into Parts** The tonnage length of a vessel having a step exceeding six inches in height in its double bottom for water ballast is divided into longitudinal parts at the step. Each part is subdivided as follows to determine the number of transverse sections:
 - (i) Parts 20 feet or under in length are divided into two equal parts.
 - (ii) Parts over 20 feet and under 40 feet in length are divided into four equal parts.
 - (iii) Parts 40 feet or over are divided as provided in paragraph (g)(1) of this section.
- (2) Summation of Tonnages** The tonnage of each part is calculated separately. The sum of the tonnages of the parts is the under-deck tonnage.

(n) Spaces Open to the Sea

In calculating the tonnage of spaces below the uppermost complete deck, subtract from each breadth measurement the portion of that measurement that spans a space, or a portion thereof, that is open to the sea. **NOTE: There are no provisions for similarly accounting for the volume of those portions of deck recesses that are below the line of the uppermost complete deck.**

(o) Open Vessels

- (1) Definition** An open vessel is a vessel without an uppermost complete deck.
- (2) Line of the Tonnage Deck** The line of the tonnage deck for an open vessel is the upper edge of the upper strake. Depths of transverse sections are taken from this line.
- (3) Restrictions on Smaller Vessels** Any vessel, other than one having a mechanically refrigerated hold, that is not an open vessel and that has a tonnage length of less than 50 feet is measured as an open vessel, if the distance between the line of its tonnage deck and the upper edge of the upper strake is more than one-sixth of the midship depth. “Midship depth” means the depth measured at

the middle of this tonnage length from the line of the upper edge of the upper strake to the point in the bottom used for measuring tonnage depths.

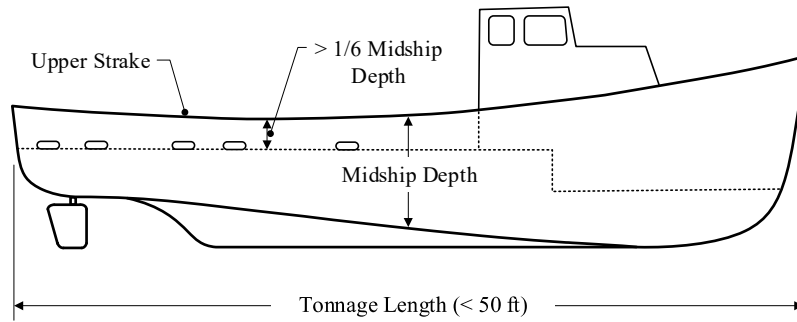

(p) General Requirements on Ordinary Frames

This section provides general requirements on ordinary frames. The ordinary frames must first be identified, and the line of the ordinary frames established, in order to determine depth and breadth measurements under § 69.109 (h) and (i).

(1) Construction *The following requirements apply.*

- (i) **Frame Intersection** *An ordinary frame must not be penetrated by an intersecting frame used to strengthen the vessel's hull, except in a vessel of wooden construction. In wooden vessels, an ordinary frame may be penetrated by an intersecting frame, provided it is attached to the intersecting frame at any point along the intersecting frame's perimeter. In vessels of other than wooden construction, an ordinary frame may be penetrated by an intersecting frame when initially assembled, provided subsequent manufacturing steps are taken to render the final assembly to appear as an integral unit by attachment along at least 50% of the intersecting frame's perimeter.³*

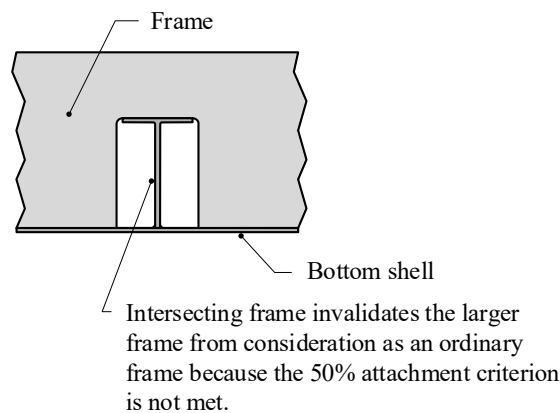

³ These provisions permit limber holes, snipes, and similar frame edge openings of relatively small size to be fitted to facilitate drainage, welding, stress reduction and the like, without their being treated as frame openings through which the intersecting frame penetrates. The Marine Safety Center may authorize similar treatment for other arrangements, provided it is demonstrated that the openings do not result in frame penetration in this context. In evaluating such requests, the Marine Safety Center will take into consideration the relative sizes and characteristics of the openings and frames, the locations of the openings, and the nature of attachment (e.g., single vs. double continuous welding).

(ii) Material and Hull Attachment Ordinary frames must be of the same material, or have the same material properties, as the adjacent hull, and attach to the adjacent hull to at least the same extent as adjacent ordinary and normal frames. *If this hull attachment criterion is not met, then the entire frame is not considered as an ordinary frame. The Marine Safety Center will consider written requests to establish equivalency of material properties of dissimilar materials, provided it is demonstrated that the frame material strength equals or exceeds the hull material strength.*

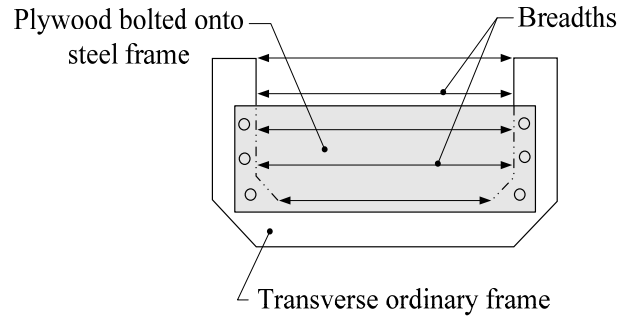

(iii) Framing Comprised of Different Elements If comprised of different elements, the elements must be joined to each other to the same extent that the frame is joined to the hull.

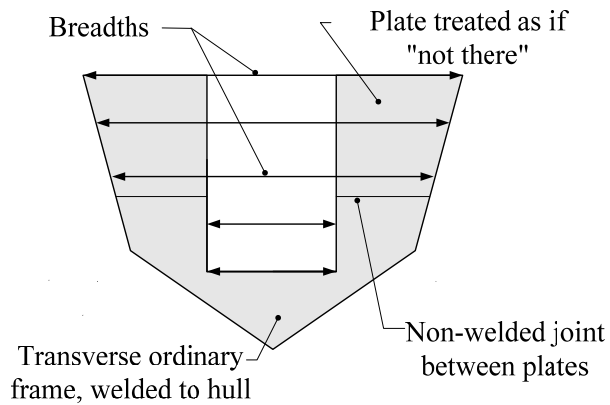

(iv) Non-Compliant Framing The frame, or portions thereof, not meeting these requirements must be treated as if not there when establishing the line of the ordinary frames.

(2) **Frame Spacing and Extension** Ordinary frames used to establish the line of the ordinary frames must be spaced on centers that are a maximum of four feet apart. These frames must extend for a length of at least one tonnage interval (L_{TI}) that begins at, ends at, or crosses the associated tonnage station. *Otherwise, the line of the ordinary frames is taken at the inboard surface of the skin of the hull at the tonnage station of interest.* For a longitudinally-framed vessel, the frames must begin and end at a transverse ordinary frame or at the vessel's hull.

Example 1

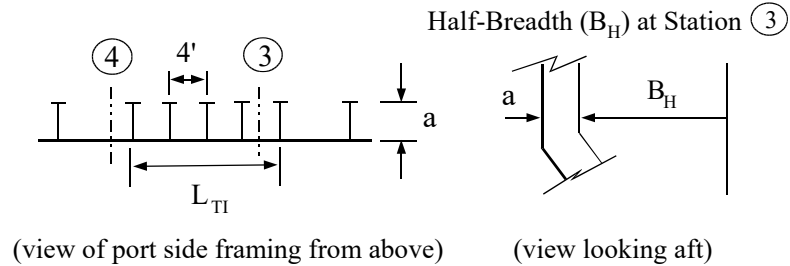

Example 2

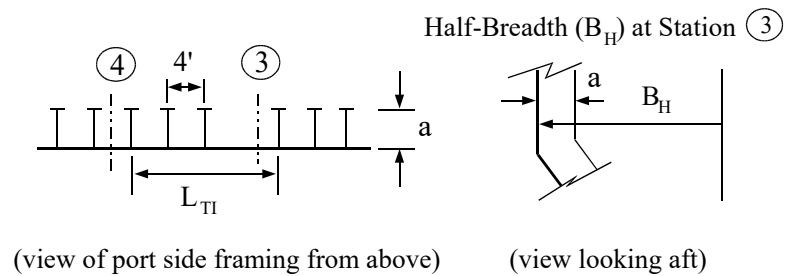

(3) **Different Sized Framing** When an ordinary frame has a different depth of frame than an adjacent ordinary frame, the line of the ordinary frames is established using the set of alternating frames that yields the smallest sectional area at the associated tonnage station, with the sectional area based on the frame with the smallest depth of frame in the chosen alternating set.

Example 1

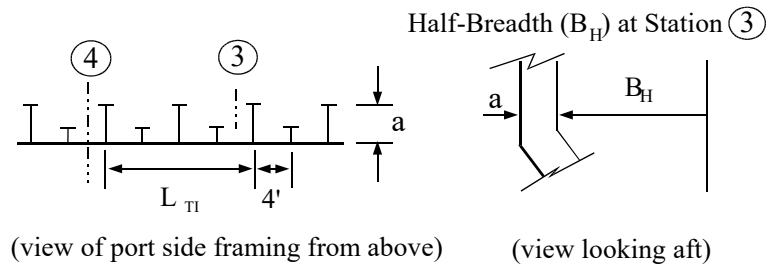

Example 2

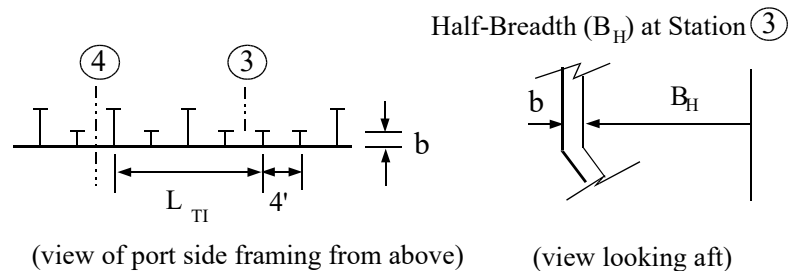

(4) **Frame Openings** The following requirements apply:

- (i) *General* If an opening in an ordinary frame is oversized, or is penetrated by a frame other than an ordinary frame, the line of the ordinary frames is established as if the frame material above and inboard of the opening is not there.

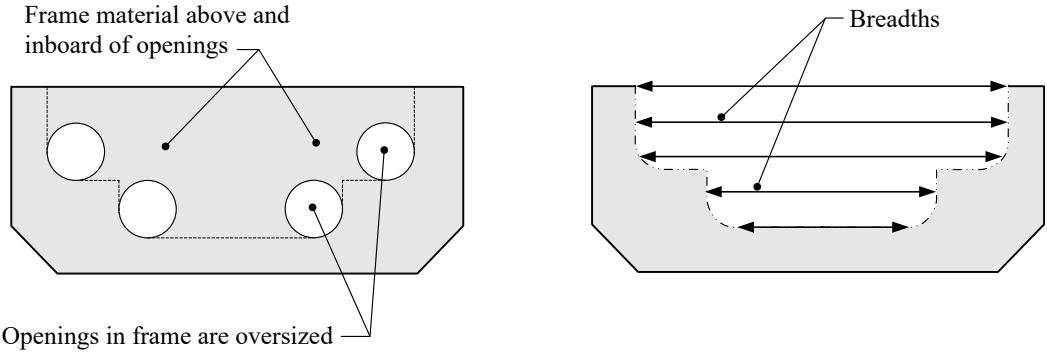

- (ii) *Proximity* Similarly, frame material separating adjacent openings that are within the longest linear dimension of either opening must be treated as if not there when establishing the line of the ordinary frames. *Limber holes, snipes, and similar small openings on the edges of ordinary frames are ignored when applying this proximity criterion, provided the separation distance between the opening within the web and the frame-edge opening exceeds the longest frame edge opening in question.*

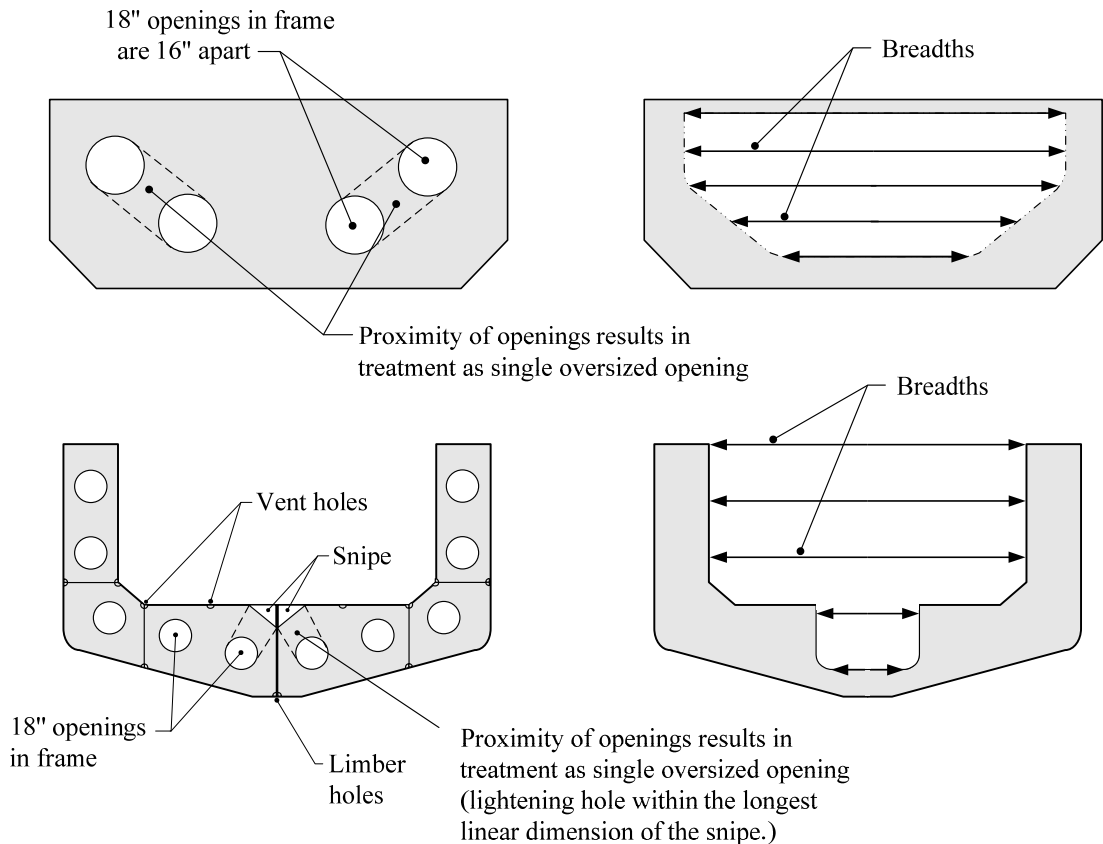

(iii) Criteria for Oversized Openings An opening is oversized if the opening is--

- (1) Circular Circular in shape with a diameter exceeding 18 inches;
- (2) Oval Oval in shape of a size greater than 15 X 23 inches (i.e., either the minor axis exceeds 15 inches or the major axis exceeds 23 inches, and the oval's area exceeds 255 square inches (345 square inches in a fuel tank)); or
- (3) Any Other Shape Any shape other than circular or oval, whose area exceeds 255 square inches (345 square inches in a fuel tank).

(iv) Opening Location An opening that is not oversized may be situated in any location within, or along the outboard edge of, the frame without affecting the line of the ordinary frame, provided the proximity requirements of this section are met. A "notch" at the upper edge of a deep transverse frame is considered to be an opening "within" the frame when there is decking present that effectively serves as the flange for the web.

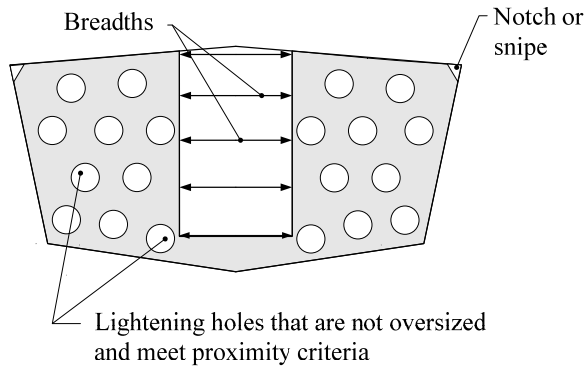

(v) Installations Through Openings If a deck stiffener or similar structural member passes through an opening that is not oversized, that opening shall be treated in the same manner as an opening that is oversized. Under the requirements of § 69.109(p)(1)(i), an intersecting structural member that is used to strengthen the vessel's hull would preclude the frame from being considered as an ordinary frame, regardless of opening size, if it passes through the frame opening. **NOTE: Piping, ventilation, cabling, shafting and similar items of a non-structural nature may be run through the openings without affecting breadth measurements.**

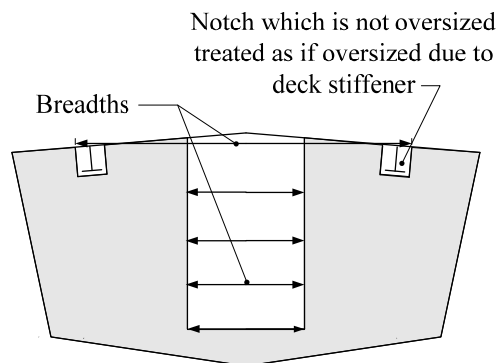

- (5) **Asymmetrical framing** Where ordinary frames are configured such that the line of the ordinary frames would be asymmetrical about the centerline of the vessel, breadth measurements are determined by taking half-breadths on the side of the vessel that yields the greatest sectional area at the associated tonnage station, and multiplying those half-breadths by a factor of two to yield the full breadths.

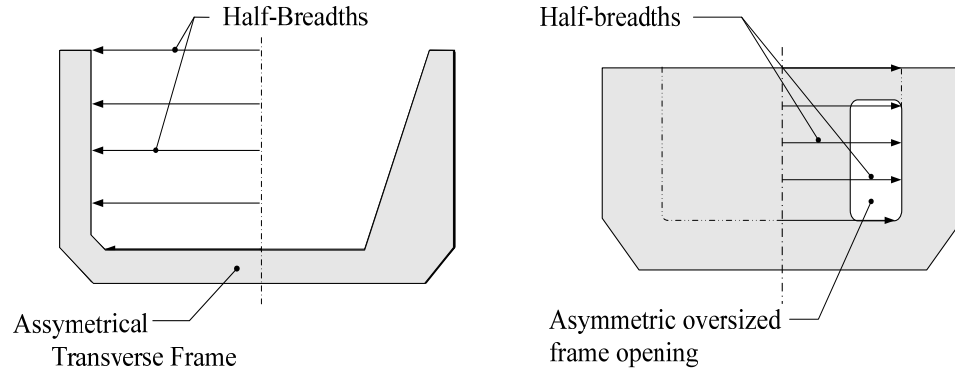

- (6) **Additional Requirements on Transverse Framing** The following requirements apply to vessels fitted with transverse ordinary frames:

- (i) **Side Frames** In order to be considered an ordinary side frame, the frame must extend from the turn of bilge up to the line of the tonnage deck, with a measurable "depth of frame" at all points along its length. If the former condition is not met, the portion of a side frame above the turn of bilge is treated as if it were not there. **NOTE: Requirements of § 69.109(p)(4) on attachment of transverse bottom floors or framing to ordinary side frames preclude alternating transverse side frames and bottom floors from being considered as ordinary frames.**

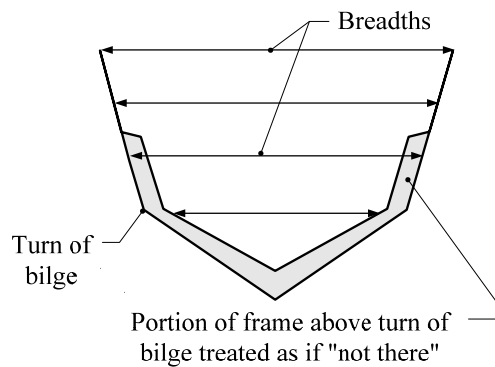

(ii) Adjustments to the Line of the Ordinary Frames Except in situations involving tumblehome, the line of the ordinary frames is established as if the portions of frames that are above and inboard of the outboard most point along the unadjusted line of the ordinary frames were not there. In situations involving tumblehome, the line of the ordinary frames should “follow the hull” above this outboardmost point.

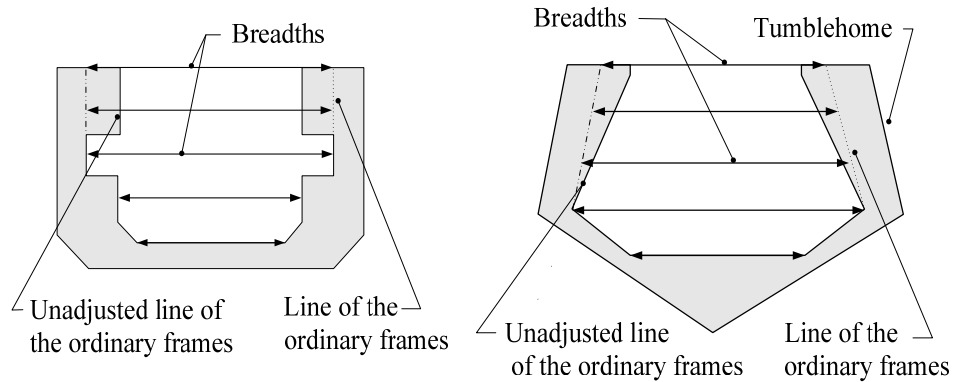

(7) **Additional Requirements on Longitudinal Framing** The following requirements apply to vessels fitted with longitudinal ordinary frames:

(i) General If the longitudinal framing to be used as the basis for establishing the line of the ordinary frames does not run the length of at least one tonnage interval (L_{TI}) either crossing, beginning at, or ending at the tonnage station of interest, the line of the ordinary frames is taken at the inboard surface of the skin of the hull at the tonnage station of interest. Also, if the uppermost ordinary frame is below but within 4 feet of the line of the tonnage deck, the upper portion of the line of the ordinary frames is taken as the continuation of the line drawn between the faces of the upper two ordinary frames (before applying any adjustments under § 69.109(p)(6)(ii)). The web of an ordinary longitudinal frame must not rest directly on bottom frames or floors (“ceiling on floors”) or otherwise serve as a deck.

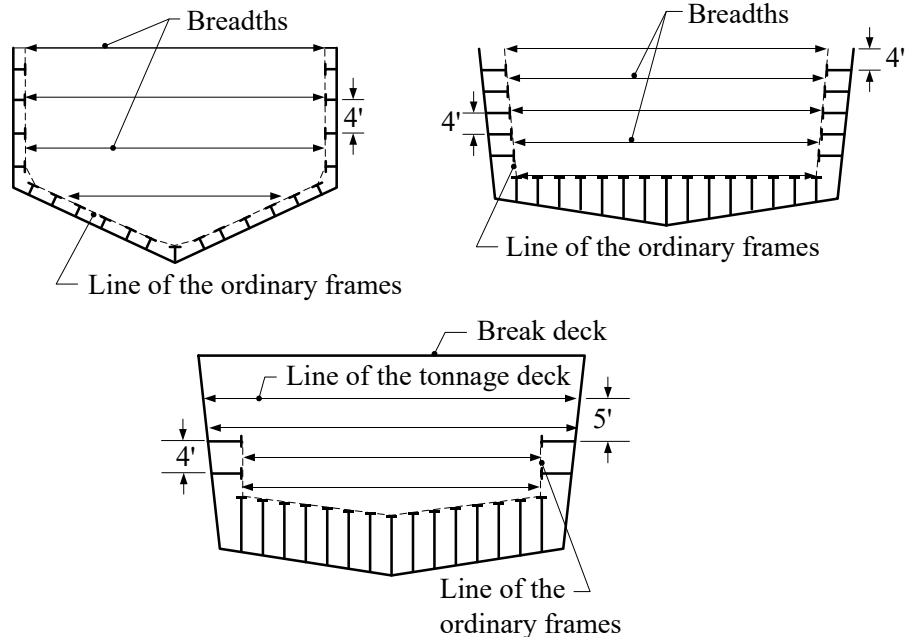

(ii) Different Sized Framing Different sets of bottom frames and side frames may be selected in order to yield the smallest sectional area at the tonnage station of interest, provided there are at least two alternate ordinary frames in each set.

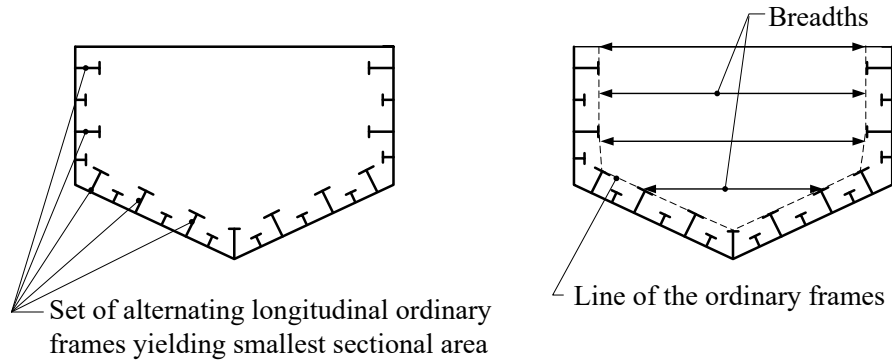

(iii) Frame Openings If a longitudinal frame opening is oversized per § 69.109(p)(4), the line of the ordinary frames is established as if the portion of the longitudinal frame above and/or inboard of the outboard-most edge of the opening is not there.

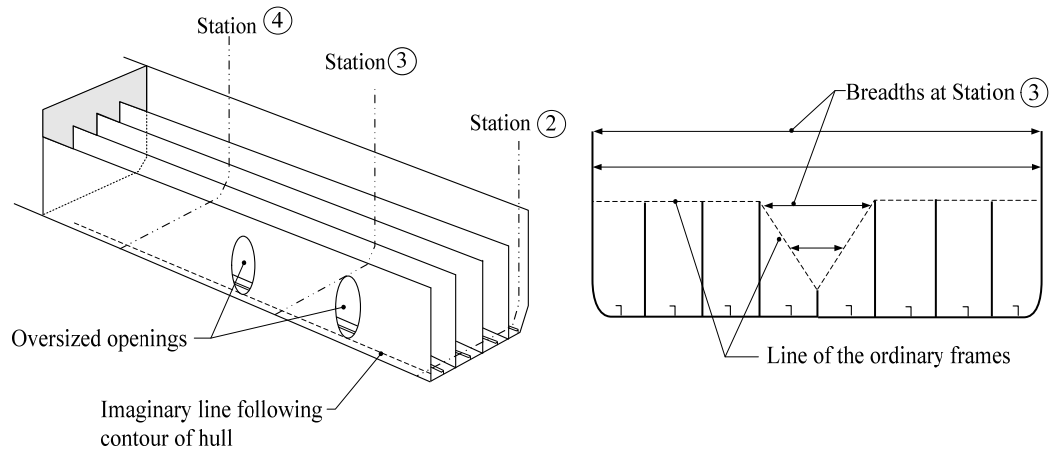

(iv) Requirements for Terminating Transverse Frames For the case of longitudinal ordinary frames that end on a transverse frame, the following requirements apply to the terminating transverse frames:

(1) Portions of Frames Above Terminating Frames The portions of those longitudinal frames that are above/inboard of the terminating transverse frames are treated as if they were not there when establishing the line of the ordinary frames.

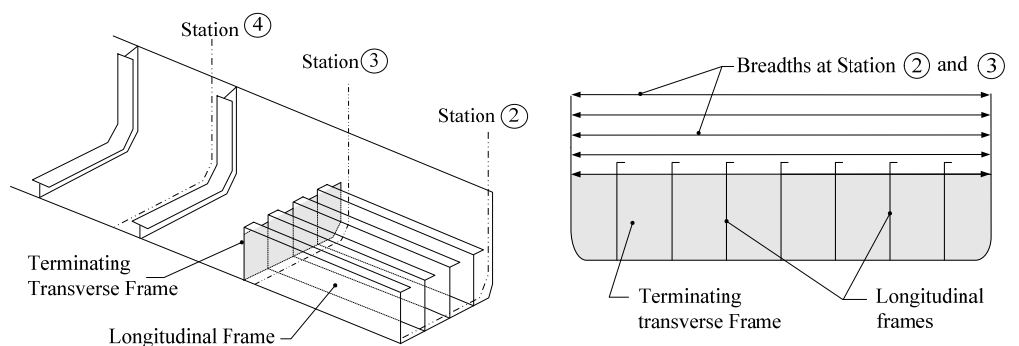

- (2) Oversized Openings If an opening in a terminating transverse frame(s) is oversized per § 69.109(p)(4) and overlaps any portion of a longitudinal ordinary frame, the portion of the longitudinal ordinary frame that is above the opening is treated as if it were not there when establishing the line of the ordinary frames. The same treatment applies to a combination of openings whose proximity creates a single oversized effective opening under § 69.109(4).

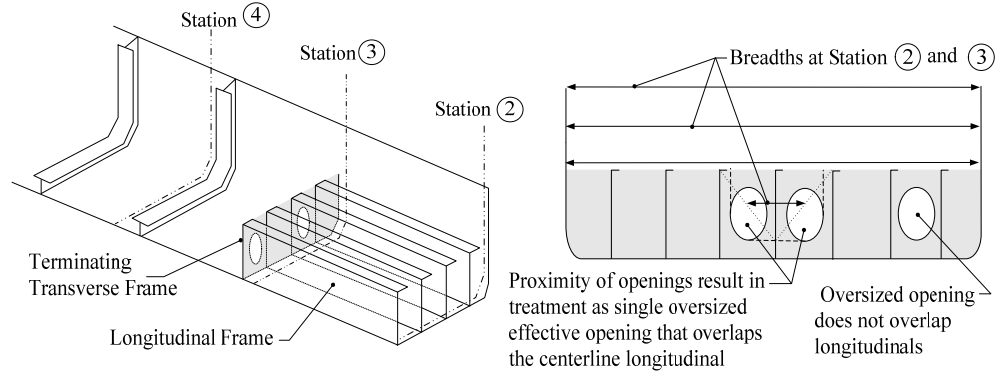

- (v) Transition Between Side and Bottom Frames The following requirements apply:

- (1) Longitudinal Side Frames and Transverse Bottom Frames In order for the lowest frame in a longitudinal side framing sequence to be considered as an ordinary frame, its centerline must be located within 4 feet of the bottom skin of the hull, an ordinary bottom frame or floor used to establish the line of the ordinary frames, or the inner bottom in the case of a double bottom for water ballast. If the lowest frame does not meet this condition, the line of the ordinary frames is established as if all longitudinal side frames were not there.

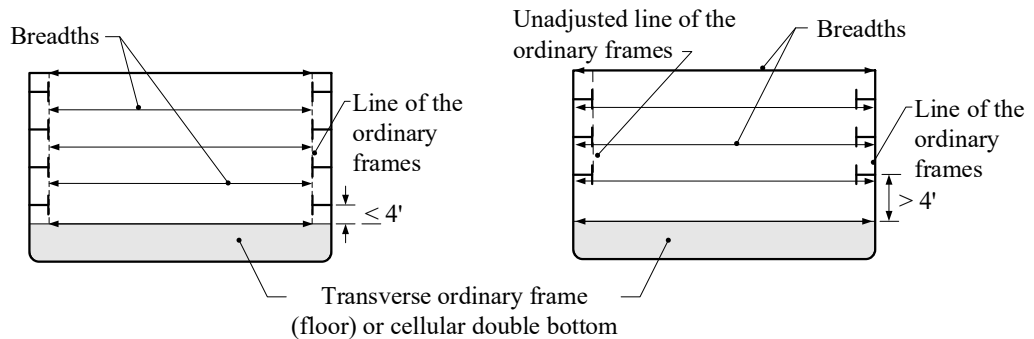

(2) Transverse Side Frames and Longitudinal Bottom Frames A transverse side frame that continues below the turn of bilge is considered part of a bottom framing system. However, if a longitudinal bottom frame penetrates such a transverse side frame, the line of the ordinary frames is established as if the frame material that is above and inboard of the outboardmost portion of the notch in the transverse frame were not there.

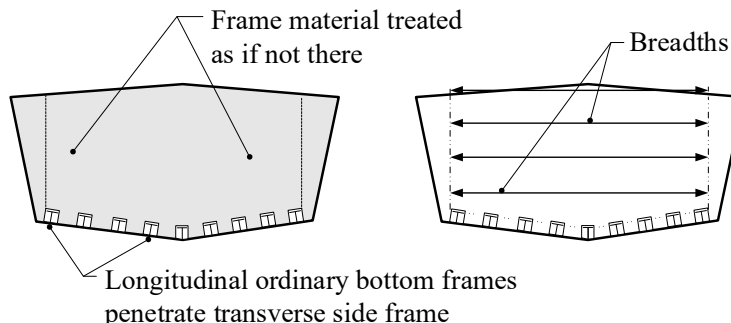

(vi) Adjustments to the Line of the Ordinary Frames Except as indicated below, establish the line of the ordinary frames as if the portions of frames that are above and inboard of the outboardmost point along the unadjusted line of the ordinary frames were not there. In situations involving tumblehome, the line of the ordinary frames should “follow the hull” above this outboardmost point. Refer to § 69.109(q)(6) for treatment of unconventional hull forms. Also, where an ordinary bottom frame (or double bottom for water ballast tank top) is outboard of the inboard face of an ordinary side frame, the line of the ordinary frames is adjusted so that it runs vertically from the inboard face of the lowest ordinary side frame that is above the line of the ordinary frames down to the line of the ordinary bottom frames (or double bottom (water ballast) tank top).

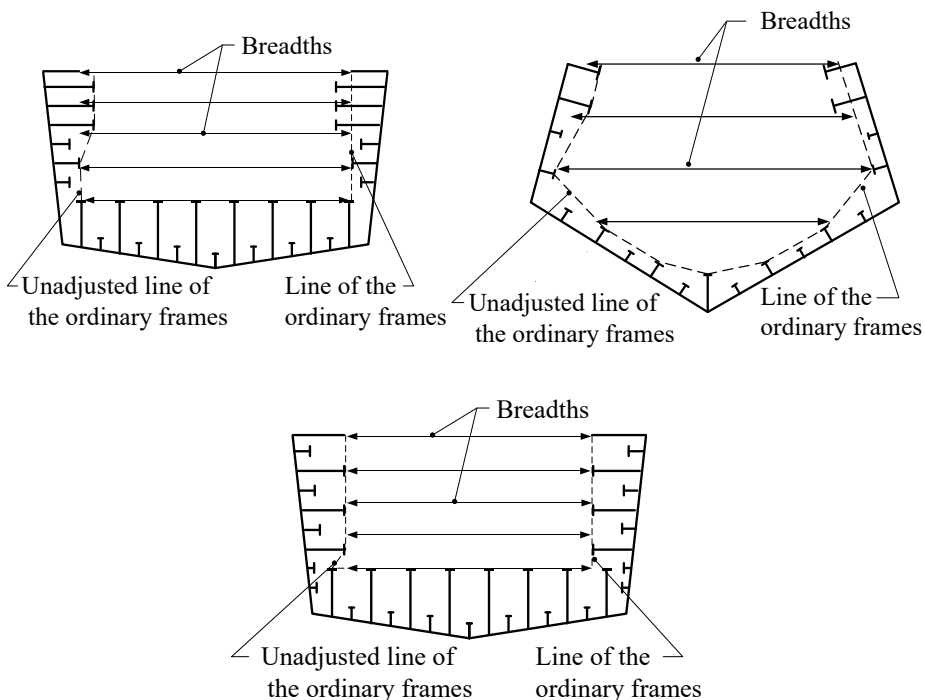

(vii) *Examples* The following examples illustrate the application of the requirements of this section for situations involving longitudinal framing systems with different depths of web. All cases assume: 1) the tonnage section shown is situated in a parallel midbody, where the framing continues without interruption or change for the length of a tonnage interval; 2) the spacing between the bottom and side frames is 4 feet or less; and 3) the vessel's midpoint depth is 16 feet or less, so there are five breadth measurements and not seven.

Example 1

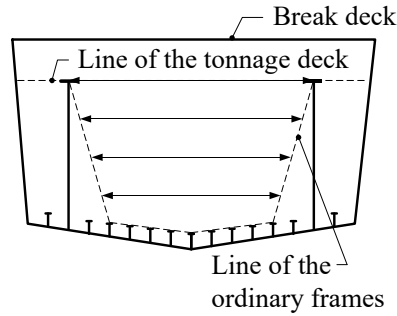

Example 5

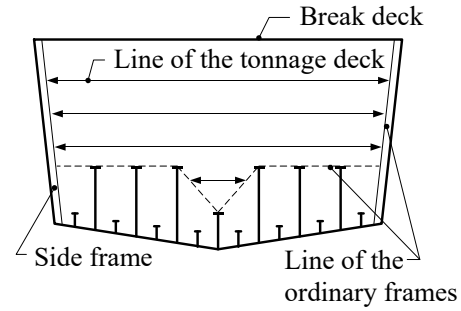

Example 2

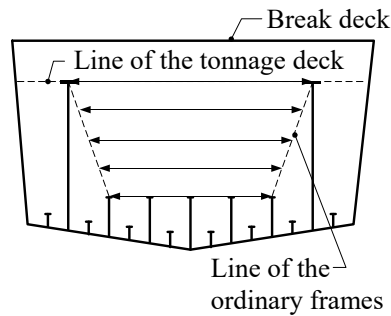

Example 6

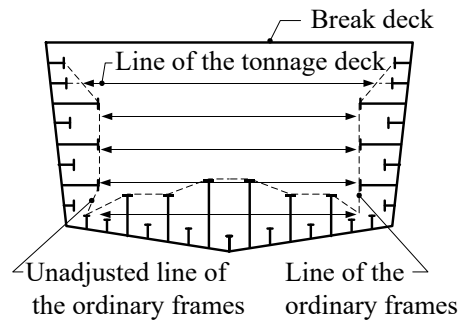

Example 3

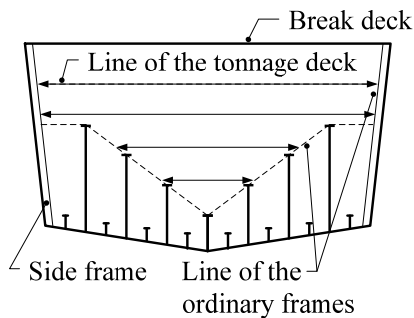

Example 7

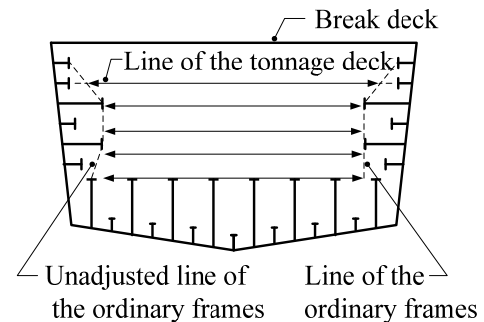

Example 4

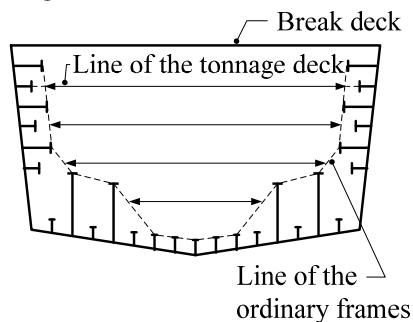

Example 8

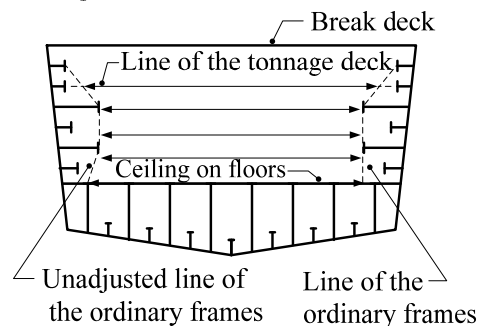

(8) **Bottom Framing** To qualify as an ordinary bottom frame (floor), the frame must be attached to the bottom skin of the vessel inboard of the turn of bilge, and meet all the requirements of ordinary transverse or longitudinal framing. In addition, the following requirements apply:

(i) **General** The lower terminus of the tonnage depth must coincide with the vertical location where the line of the ordinary frame at the tonnage station of interest is the lowest. Except as provided for in § 69.109(i)(4), the lowest breadth measurement is taken horizontally at that location.

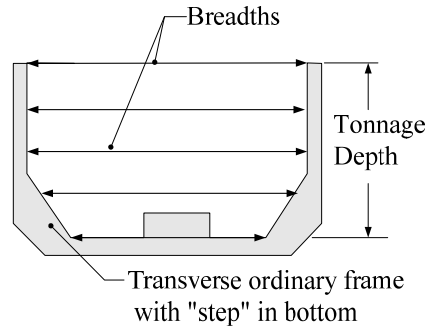

(ii) **Longitudinal Bottom Frames** In the case of ordinary longitudinal bottom frames, the frames need only run continuously side to side (i.e., turn of bilge to turn of bilge); in other words, the frames need not continue up the sides of the vessel

(iii) **Transverse Bottom Frames** Ordinary transverse bottom frames must attach to ordinary side frames, if the vessel is fitted with ordinary side frames.

(q) Unconventional Hull Forms

This section provides supplemental requirements to be used in determining the under-deck tonnage in vessels having unconventional hull forms, such as multihull vessels.

(1) **Identifying the Tonnage Deck** Identify the tonnage deck using the criteria provided in § 69.109(d). In this context, a watertight bottom skin (or "wet deck") between hulls that remains above the vessel's design waterline may be considered as part of the tonnage deck and/or uppermost complete deck.

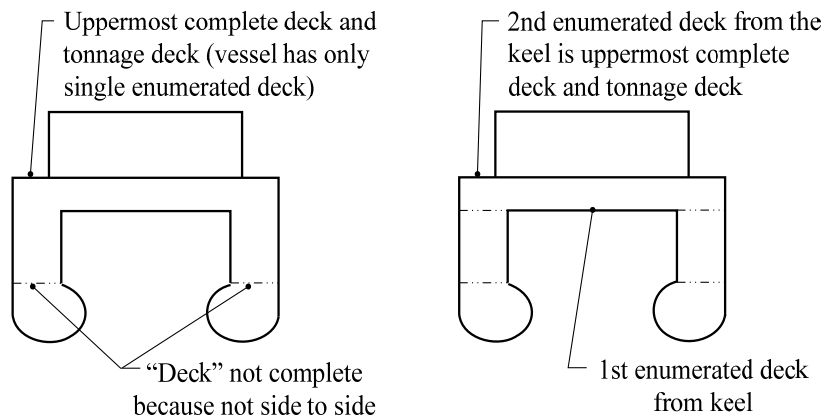

- (2) **Establishing Tonnage Length** Refer to § 69.109(f). For vessels with complex stem and stern geometries, the tonnage length is the distance between two planes that are perpendicular to the longitudinal axis of the vessel and tangent to the imaginary surface bounding the inboard faces of the ordinary frames at the extreme fore and aft locations of this surface.

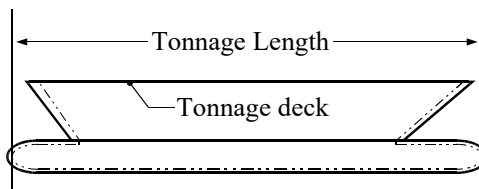

- (3) **Establishing Transverse Sections** Once the tonnage length is established, the vessel is divided into transverse sections using the method of § 69.109(g).

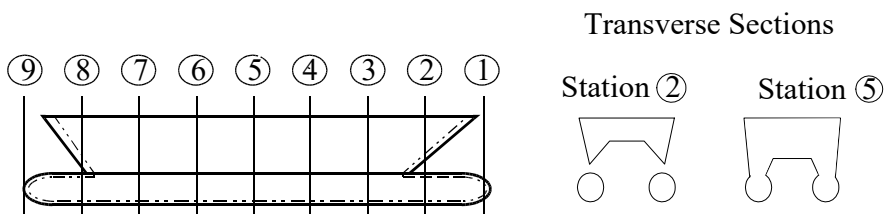

- (4) **Identifying Ordinary Frames** These frames are identified in the same manner as for conventional hulls. The same restrictions apply for establishing which are the qualifying ordinary frames as apply to conventional hull forms (refer to the general requirements of § 69.109(p)). For example:

- (i) Frames must be spaced on centers that are a maximum of four (4) feet apart across an associated tonnage interval.
- (ii) If there are different sized frames, the largest sized frames that alternate with smaller frames and are spaced on centers that are a maximum of eight (8) feet apart across an associated tonnage interval are used as the basis for establishing the line of the ordinary frames.
- (iii) Frames must be continuous from the bottom of the vessel to the tonnage deck.

If no framing across an associated tonnage interval qualifies, the line of the ordinary frames is taken at the inner surface of the hull shell for the tonnage station of interest.

- (5) **Establishing the Unadjusted Line of the Ordinary Frames** The unadjusted line of the ordinary frames is defined as the line of intersection of: 1) the imaginary surface that is tangent to the inboard faces of the ordinary frames; and 2) the imaginary plane running transversely through the vessel at the tonnage station of interest.

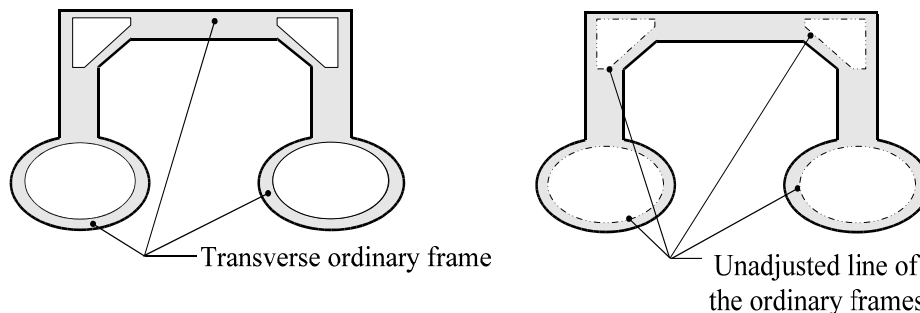

(6) **Establishing the Line of the Ordinary Frames** The following method is used to establish the line of the ordinary frames at each tonnage station, to which breadth measurements are taken. Note that this process is applied only to the outboardmost portions of the hull.

(i) **Establish Offset Adjustments** Establish “offset adjustments” along the outboard sides of the hull(s). “Offset adjustments” are the series of measurements taken between the inner surface of the hull shell and the unadjusted line of the ordinary frames, in a direction perpendicular to the inner surface of the hull shell.

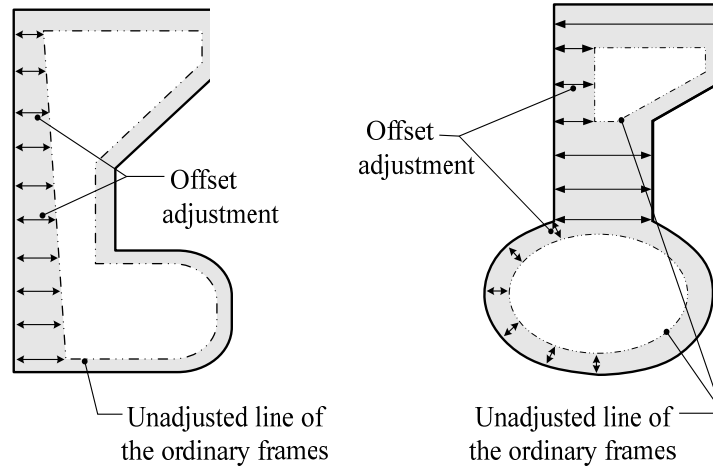

(ii) **Evaluate Each Vertical Location** Proceeding from the bottom of the vessel to the line of the tonnage deck, establish the location of the line of the ordinary frames at each vertical location above the bottom of the vessel, as follows:

(1) **Offset Adjustment Length Decreases or Remains Same** If the length of the “offset adjustment” is less than or equal to the length of the smallest offset adjustment below the location being evaluated, establish the line of the ordinary frames at the inboard terminus of the offset adjustment.

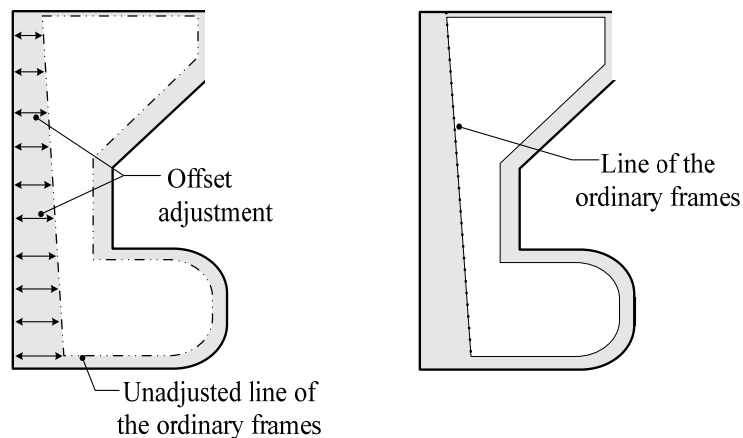

(2) Offset Adjustment Length Increases If the length of the “offset adjustment” is greater than the length of the smallest offset adjustment below, establish the line of the ordinary frames as follows:

(a) Inboard Terminus is Inboard of or Above the Point Below If the inboard terminus of the “offset adjustment” is inboard of or directly above the location of the line of the ordinary frames that is immediately below, establish the line of the ordinary frames using either step (1) or (2) below, whichever yields the smallest sectional area:

(1) Establish the line of the ordinary frames at a distance from the outer terminus of the offset adjustment that is equal to the length of the smallest offset adjustment that is below, as measured “along” the offset adjustment.

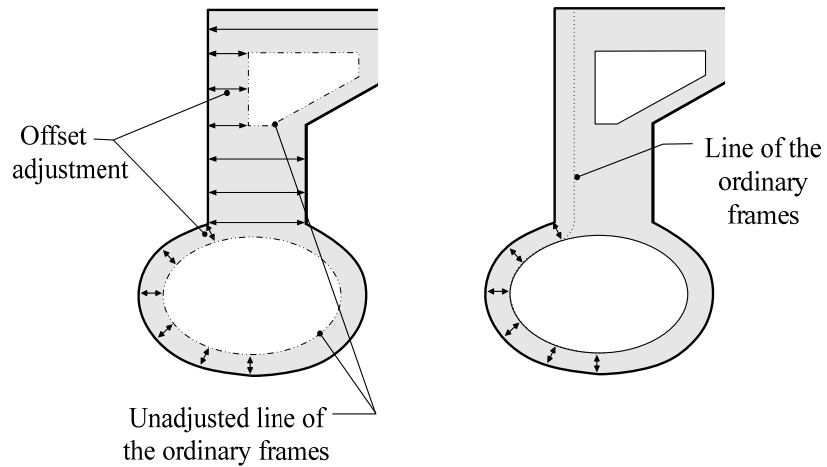

(2) Establish the line of the ordinary frames at the location directly above the location of the line of the ordinary frames for the point that is immediately below.

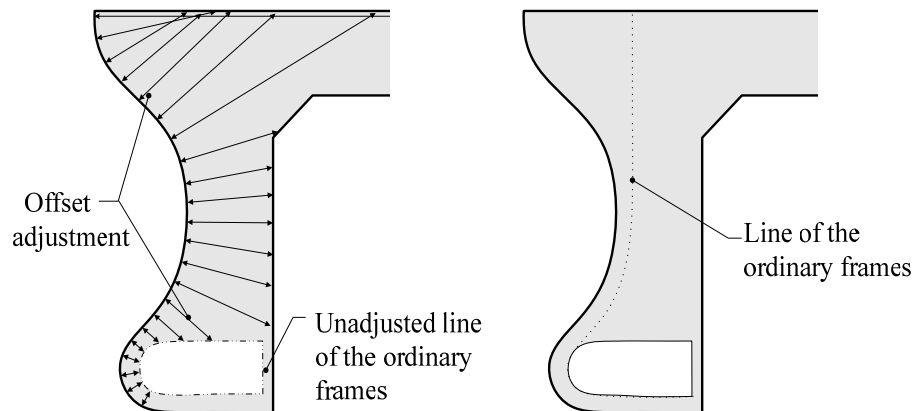

- (b) *Inboard Terminus is Outboard of the Point Below* If the inboard terminus of the “offset adjustment” is outboard of the location of the line of the ordinary frames that is immediately below, establish the line of the ordinary frames at the inboard terminus of the “offset adjustment”.

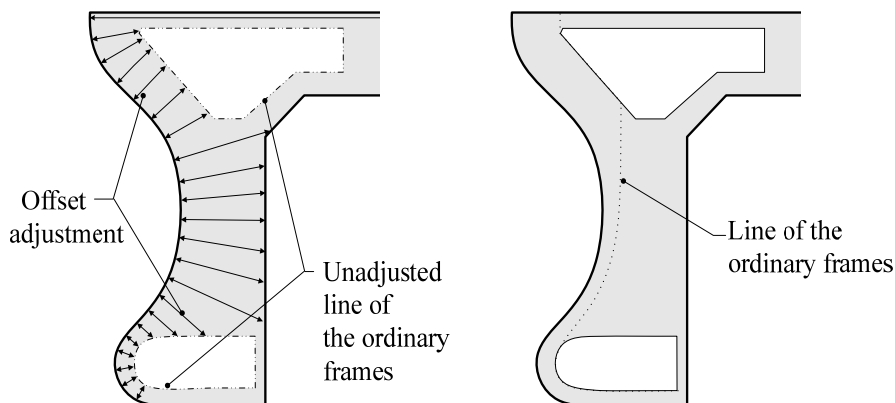

- (7) **Adjusting Breadth Measurements** The breadth measurements are adjusted to account only for the enclosed spaces by subtracting out the portion of the breadth measurement outside the hull boundary.

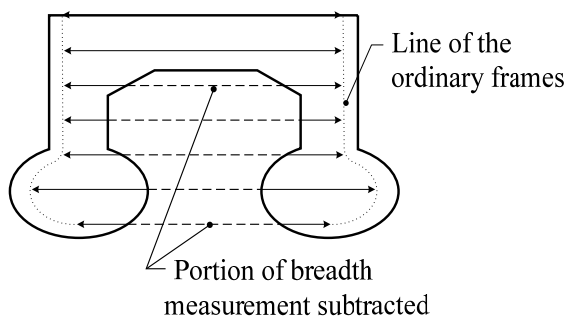

- (8) **Treatment of Wet Deck Area** Breadth measurements may be adjusted using the method of paragraph 7 above to account for that portion of the “cross-deck” or “wet deck” that is open to the sea. If this “wet deck” area is in any way enclosed, it must fully meet the requirements for exclusion as space open to the sea under the Convention Measurement System in order for the breadth measurements to be adjusted in this manner.

§ 69.111 BETWEEN-DECK TONNAGE

This section provides the method for calculating the between-deck tonnage using Simpson’s first rule. It also provides procedures for establishing the line of the uppermost complete deck.

(a) **Between-Deck Tonnage Defined**

“Between-deck tonnage” means the tonnage of the space above the line of the tonnage deck and below the line of the uppermost complete deck.

(b) **Identifying the Line of the Uppermost Complete Deck**

Establish the line of the uppermost complete deck as indicated below.

- (1) **Deck Runs in Continuous Line** If the uppermost complete deck runs in a continuous line from stem to stern, the line of the uppermost complete deck is the longitudinal line of the underside of the uppermost complete deck.

(2) **Deck Runs at Different Levels** If the uppermost complete deck is stepped, the line of the uppermost complete deck is the longitudinal line of the underside of the lowest portion (*i.e.*, *lowest longitudinal step*) of that deck parallel with the upper portion of that deck. Steps that do not extend from side to side or are less than three feet in length are ignored when establishing the line of the uppermost complete deck. Spaces between the line of the uppermost complete deck and the higher portions of the deck are included in superstructure tonnage. *Deck discontinuities that are ignored when establishing which deck is the uppermost complete deck are similarly ignored when establishing the vertical location of the line of the uppermost complete deck.*

(c) **Method of Calculating Tonnage**

The tonnage of each level of the between-deck space is calculated separately, as follows. *All longitudinal and transverse measurements used to establish between-deck tonnage are terminated at the line of the normal frames.*

- (1) **Determine Length** The length of each level is measured at the mid-height between the line of the deck above and the line of the deck below. Measure from the point forward where the continuation of the line of the inboard face of the normal frames intersects the center line of the vessel aft to the forward face of the normal transom framing.
- (2) **Establish Measurement Spacing** Divide the length *determined* under paragraph (c)(1) of this section into the same number of equal parts into which the tonnage length is divided under § 69.109(g)(1).
- (3) **Measure and Number Breadths** Measure at mid-height between the faces of the normal side frames the inside breadth of the space at each end and at each point of division of the length. Number the breadths successively “1”, “2”, and so forth beginning at the bow.
- (4) **Apply Simpson’s Multipliers** Multiply the even numbered breadths by four and the odd numbered by two, except the first and last *breadth*, which are multiplied by one.
- (5) **Determine Area at Mid-Height** Add together the products under paragraph (c)(4) of this section and multiply the sum by one-third of the interval between the points at which the breadths are taken. The product is the square foot area of the space at mid-height.
- (6) **Convert to Tonnage** Multiply the area of the space at mid-height by the average of the heights taken at each point of division of the space. The product divided by 100 is the tonnage of that space.
- (7) **Combine the Tonnage of Each Level** The between-deck tonnage is the sum of the tonnage of each level within the between-deck space.

§ 69.113 SUPERSTRUCTURE TONNAGE

This section provides the method for calculating the tonnage of all superstructures.

(a) **Superstructure Tonnage Defined**

“Superstructure tonnage” means the tonnage of all superstructure spaces.

(b) Method of Calculating Tonnage

All longitudinal and transverse measurements used to establish superstructure tonnage are terminated at the line of the normal framing. The tonnage of all structures on each level on or above the uppermost complete deck (or shelter deck, if applicable) is calculated separately as follows. This method applies to structures that are not of standard geometric shape, such as a forecastle that is faired into a non-rectangular hull form. Refer to § 69.113(f) for the method of calculating the tonnage of standard geometric shapes.

- (1) Determine Length** Measure the length of each structure along its centerline at mid-height to the line of the normal frames. (See § 69.123, figure 11.)
- (2) Establish Measurement Spacing** Divide the length *determined* under paragraph (b)(1) of this section into an even number of equal parts most nearly equal to those into which the tonnage length is divided under § 69.109, *giving a common interval most nearly equal in length to that used in calculating the under-deck tonnage.*
- (3) Measure and Number Breadths** Measure at mid-height the inside breadth to the line of the normal frames at each end and at each point of division of the length. Number the breadths successively “1”, “2”, and so forth, beginning at the extreme forward end of the structure. If an end of the structure is in the form of a continuous arc or curve, the breadth at that end is one-half the nearest breadth. If an end is in the form of an arc or curve having a decided flat, the breadth at the end is two-thirds of the nearest breadth.
- (4) Apply Simpson’s Multipliers** Multiply the even numbered breadths by four and the odd numbered by two, except the first and last breadth, which are multiplied by one.
- (5) Determine Area at Mid-Height** Add together the products under paragraph (b)(4) of this section and multiply the sum by one-third of the interval between the points at which the breadths are taken. The product is the square foot area of the structure at mid-height.
- (6) Convert to Tonnage** Multiply this area by the average of the heights taken at each point of the division of the structure between its decks or the line of its decks. The product divided by 100 is the tonnage of that structure.

(c) Treatment of Stepped Decks/Sides

A structure having steps in its deck or side must be measured in parts. **NOTE: This includes structures that bound wells and notches, as measurement by parts is necessary to insure that the volumes of the associated open spaces are not reflected in the superstructure tonnage.**

(d) Computing Superstructure Tonnage

The superstructure tonnage is the sum of the tonnages of each level above the line of the uppermost complete deck (or shelter deck, if applicable).

(e) Treatment of Spaces Open to Under-Deck

When a superstructure is located over a cut-away portion of the tonnage deck, the structure’s height is measured from the under side of its overhead deck to the line of the tonnage deck. If the tonnage deck has no camber, allow for camber in the overhead deck.

(f) Method of Calculating Tonnage (Standard Shapes)

For structures of a standard geometric shape, a simple geometric formula that yields an accurate volume may be used. All measurements are terminated at the line of the normal frames.

§ 69.115 EXCESS HATCHWAY TONNAGE

(a) **Applicability**

Hatchways that are above the tonnage deck and are either open to the weather or within open structures are measured to determine excess hatchway tonnage. Hatchways that are in between-deck spaces, on decks within closed-in structures, or on open structures are not measured.

(b) **Method of Calculating Tonnage**

The tonnage of a hatchway is its length times breadth times mean depth divided by 100. Mean depth is measured from the under side of the hatch cover to the top of the deck beam.

(c) **Determining Excess Hatchway Tonnage**

From the sum of the tonnage of the hatchways under this section, subtract one-half of one percent of the vessel's gross register tonnage exclusive of the hatchway tonnage. The remainder is added as excess hatchway tonnage in calculating the gross register tonnage.

§ 69.117 SPACES EXEMPT FROM INCLUSION IN TONNAGE

(a) **Purpose**

This section lists spaces which are exempt from inclusion in tonnage.

(b) **Spaces On or Above the Line of the Uppermost Complete Deck**

The following spaces or portions of spaces on or above the line of the uppermost complete deck are exempt *from inclusion in tonnage* if the spaces or portions are reasonable in extent and adapted and used exclusively for the purpose indicated:

- (1) **Anchor Gear** Spaces for anchor gear, including capstan, windlass, and chain locker, are exempt.
- (2) **Companions** Companions and booby-hatches protecting stairways or ladderways leading to spaces below are exempt, whether or not the spaces below are exempt. *A companion is a structure sheltering a deck opening affording entrance to a companionway. Where the stairways or ladderways span multiple tiers, only the companion space on the uppermost tier may be exempted.*
- (3) **Galley** Galley or other spaces fitted with a range or oven for cooking food to be consumed onboard the vessel are exempt.
- (4) **Light or Air** Spaces designed to provide light or air to propelling machinery are exempt, as follows:
 - (i) When propelling machinery is located entirely on or above the line of the uppermost complete deck, the entire propelling machinery space and all fuel bunker spaces that are also located above that line are exempt as light or air spaces. (See exceptions in § 69.121(d)(1) for framed-in spaces.)
 - (ii) When part of the propelling machinery projects above the line of the uppermost complete deck into a space used exclusively to provide light or air to the propelling machinery, the entire space is exempt as light or air space. When any portion of this space is used for purposes other than providing light or air, only the portion of the space used for light or air, the space occupied by the propelling machinery itself, and a propelling machinery working space allowance under § 69.121 limited to two feet, if available, on each side of the propelling machinery are exempt.

- (iii) Any part of an escape shaft, or a companion sheltering an escape shaft, above the line of the uppermost complete deck is exempt as light or air space.
- (iv) Space that would otherwise be exempt as a light or air space is not exempt when propelling machinery is boxed-in and does not extend above the line of the uppermost complete deck. Any portion of the boxed-in space above the line of the uppermost complete deck is exempt.
- (5) **Skylights** Skylights affording light or air to a space below, other than to propelling machinery spaces. Space immediately below the line of the deck on which a skylight is located is exempt only when there is an opening in the next lower deck directly below the skylight to permit light or air to an even lower deck.
- (6) **Machinery Spaces** Machinery spaces, other than for propelling machinery under § 69.121.
- (7) **Steering Gear** Spaces for steering gear.
- (8) **Water Closets** Water closet spaces that are fitted with at least a toilet and are intended for use by more than one person. *In this context, “use by more than one person” means “use by more than one specific individual”, rather than “use by more than one person simultaneously”, thereby permitting a water closet in a multiple occupancy passenger cabin to be exempted as water closet space. Areas within a water closet space that are occupied by showers and sinks may be exempted as part of the associated water closet space.*
- (9) **Wheelhouse** The space in a wheelhouse necessary for controlling the vessel.

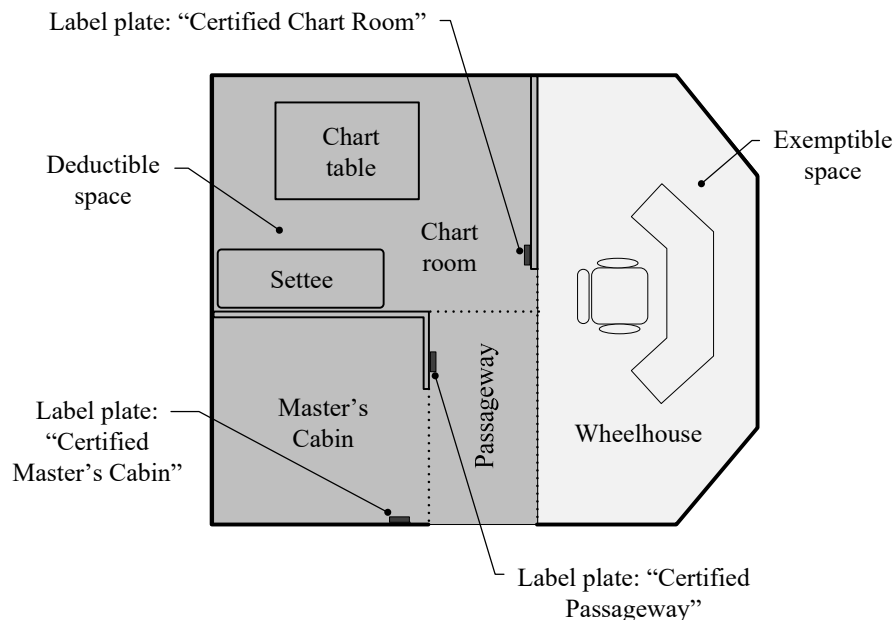

(c) Passenger Spaces

- (1) **Passengers on Military Vessels** As used in this section, the term “passenger” includes officers and enlisted men on military vessels who are not assigned ship’s duties and not entered on the ship’s articles.
- (2) **Definition of Passenger Space** As used in this section, “passenger space” means a space reserved exclusively for the use of passengers and includes, but is not limited to, berthing areas, staterooms, bathrooms, toilets, libraries, writing rooms, lounges, dining rooms, saloons, smoking rooms, and

recreational rooms. The space need not be part of or adjacent to a berthing area to be considered a passenger space. Spaces used by both passengers and crew members (e.g., first aid stations), or used for passenger support but not accessible to passengers at all times (e.g., vaults on a gaming vessel) cannot be exempted as passenger space.

- (3) **Restrictions on Location** A passenger space located on, or above the first deck above the uppermost complete deck is exempt from tonnage. To qualify as the first deck above the uppermost complete deck, the deck must be at least six inches above the uppermost complete deck at all points along its length. **NOTE: A space that is directly on the uppermost complete deck cannot be exempted as passenger space, even if it is above the line of the uppermost complete deck (as is the case of passenger space on a break deck).**

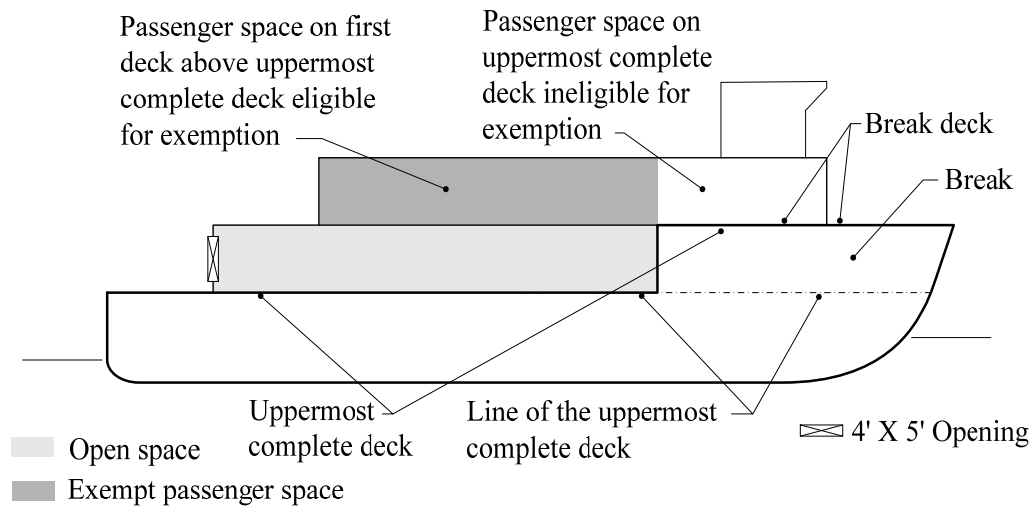

(d) **Open Structures**

- (1) **General** Structures that are located on or above the line of the uppermost complete deck that are under cover (sheltered), but open to the weather are exempt from tonnage as open space. The following additional requirements apply:

- (i) Structure Divided Into Compartments If a structure is divided into compartments, only those compartments which are open to the weather are exempt from tonnage under the provisions of this section. *In this context, a compartment is defined as a space within an open structure that is bounded by bulkheads and the deck above and below. Passageways and dead-ended recesses are considered to be part of the larger compartment to which they are connected, until such point that the passageway and/or dead-ended space increases in height or width, beyond which point the space is considered to be a separate compartment. For situations where one boundary of a compartment is not clearly defined (e.g., a situation involving corners), the “projected” boundary that delineates the compartment is taken as the continuation of the bulkhead of the compartment from which open space is progressing. Also, in those situations where an exterior bulkhead bounding the compartment is absent, the outermost edge of the deck overhead delineates the boundary of the compartment.*

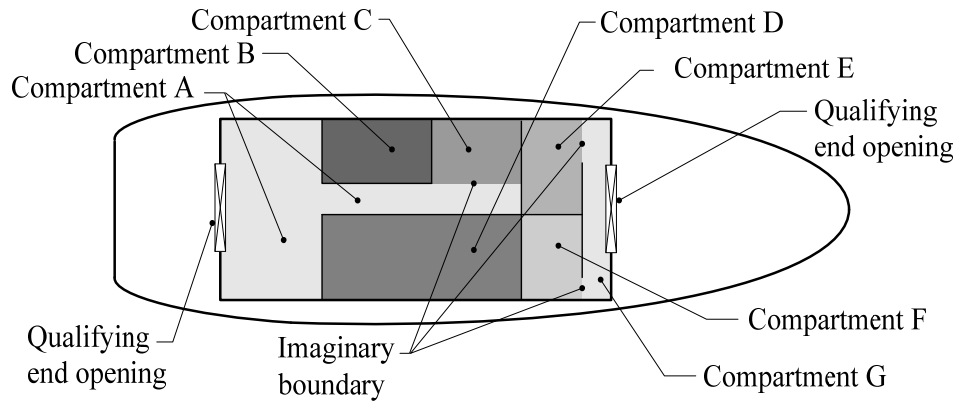

- (ii) Progression of Open Space Vertically and Between Structures Open space cannot progress vertically through openings in a deck within the structure (e.g., from a sunken forecastle to a break aft of the forecastle), nor can it progress from one structure into another structure.

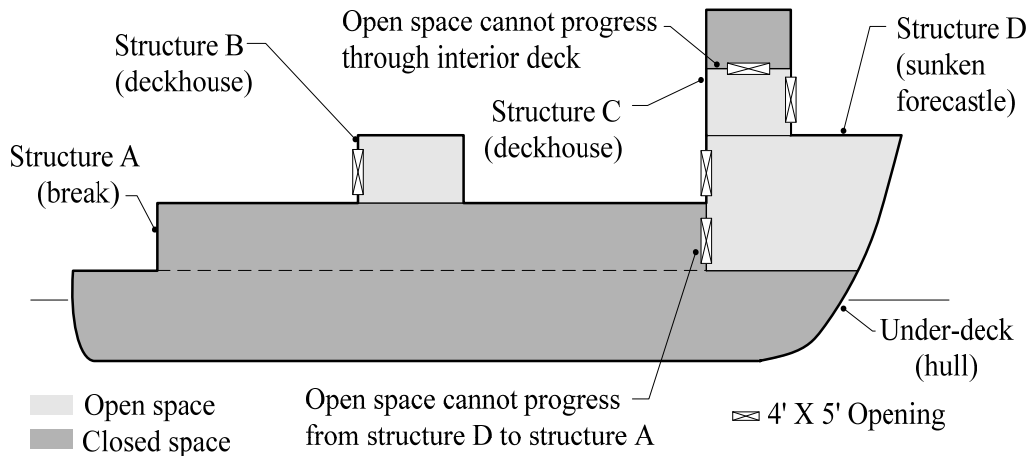

- (iii) Treatment of Spaces Outside of Boundary Bulkheads A space that is outside a structure's boundary bulkhead as defined in § 69.53 is considered open to the weather provided the space is eligible to be treated as an excluded space under the provisions of § 69.61, regardless of whether or not the space is fitted with means designed for securing cargo or stores.

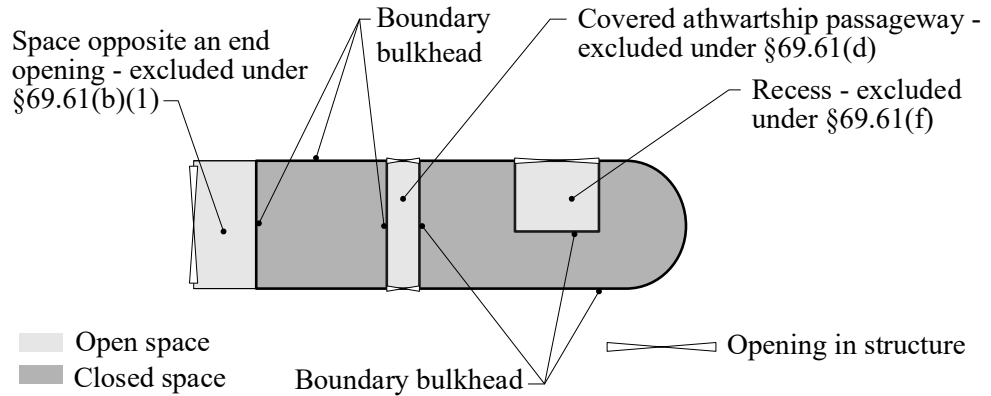

- (2) End Openings A structure is considered open to the weather when an exterior end bulkhead of the structure is open and, except as provided in paragraphs (d)(4), (d)(5), and (d)(6) of this section, is not fitted with any means of closing. To be considered open to the weather, the end bulkhead must not have a coaming height of more than two feet in way of any required opening (*as measured to the deck outside the opening*) nor any permanent obstruction within two and one-half feet of the opening, it must be fitted with a deck or platform that is a minimum of two and one-half feet wide on the exterior side of the opening, and it must have one of the following:

- (i) Two 3' X 4' Openings Two openings, each at least three feet wide and at least four feet high in the clear, one on each side of the centerline of the structure. If the openings lead to two separate interior compartments, there must be circulation of open space between the two compartments via a single such opening, or series of such openings, in the intermediate bulkhead(s). *If such circulation does not exist, both openings are considered closed.*

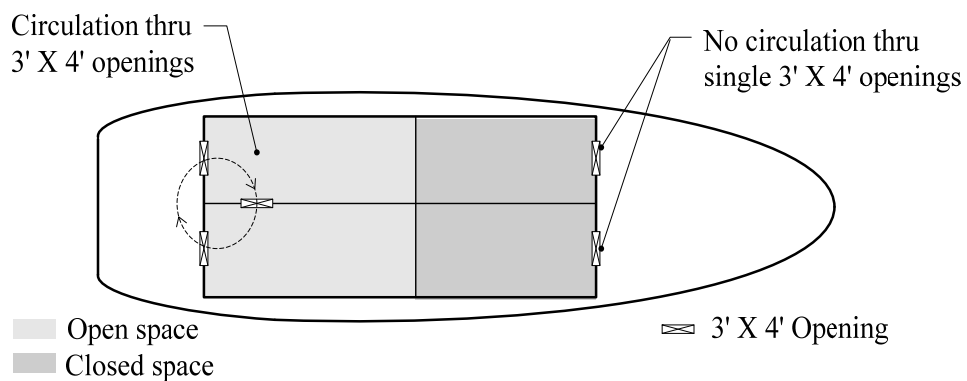

(ii) One 4' X 5' Opening One opening at least four feet wide and at least five feet high in the clear.

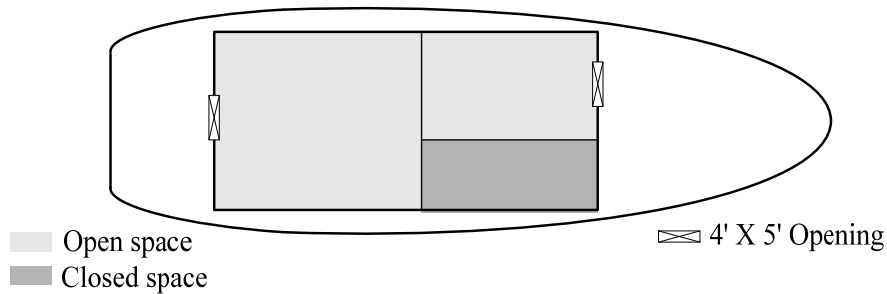

(iii) One Equivalent Opening One opening at least 20 square feet in the clear with a breadth in excess of four feet and a height of not less than three feet.

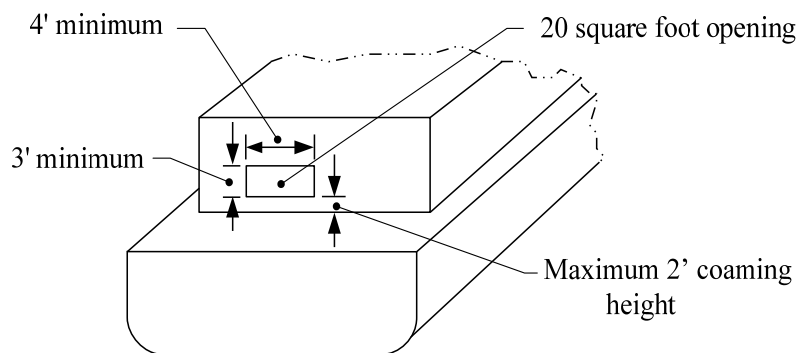

(2') **Additional Requirements for End Openings** In addition to the requirements of § 69.117(d)(2), the following requirements apply to end openings:

(i) In the Clear Requirement To be considered in the clear as described in § 69.117(d)(2), the opening must be unobstructed for a distance of 30 inches both inside and outside of the opening. Obstructions of a temporary nature (i.e., that are not permanently attached to the vessel, can readily be removed underway, and whose removal does not adversely impact the safe operation of the vessel) are not considered to violate the in the clear requirement. For example, portable furniture and lockers are considered to be of a temporary nature, whereas bulkheads, stanchions, bunks that are part of joiner work, and handrails are not. In all cases, attachments to temporary covers authorized under § 69.117(d)(6') and deck cargo are not considered to violate the in the clear requirement.

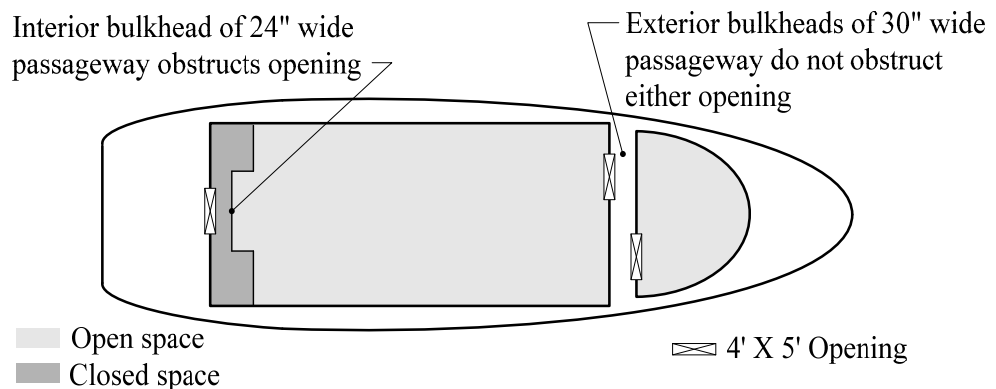

(ii) Minimum Opening Dimensions Minimum opening dimensions must be maintained throughout the entire width and height of the opening. For example, coamings, shifting board channel sections, and rounded corners must not infringe on minimum width and height requirements of the opening.

(iii) Progression of Open Space Within the Structure: Open space is considered to progress from openings meeting the minimum requirements of this section throughout the associated interior compartment. Obstructions within the compartment (e.g., passenger seating, stanchions, false ceilings, handrails, and furniture) are not considered to interfere with the progression of open space within the same compartment, whether or not the obstructions are temporary in nature. However, such obstructions installed within 30 inches of an end bulkhead opening could cause the entire compartment to be treated as closed, depending on whether or not the obstruction is temporary in nature as described in § 69.117(d)(2')(i).

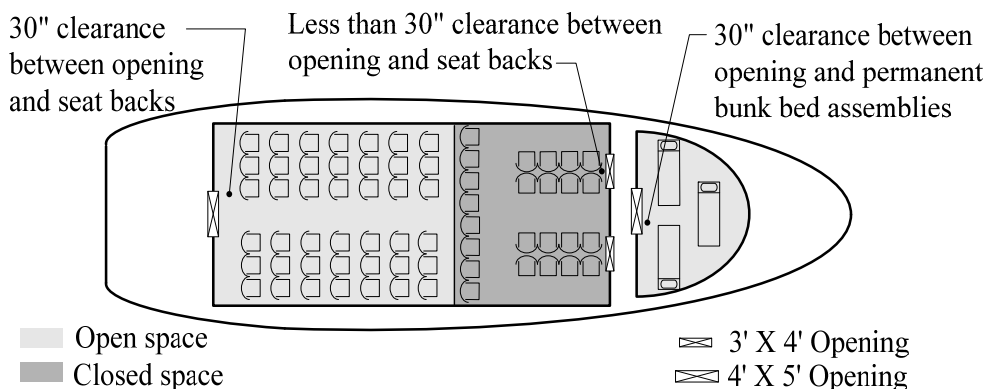

(iv) Angled or Curved Bulkheads To qualify as an end bulkhead, the portion of the bulkhead in way of a qualifying opening must not be oriented any greater than 45 degrees from the horizontal or athwartship planes. Width, height and area requirements for openings in angled or curved end bulkheads are applied to the longitudinal projection of the opening onto a vertical athwartship plane at the opening.

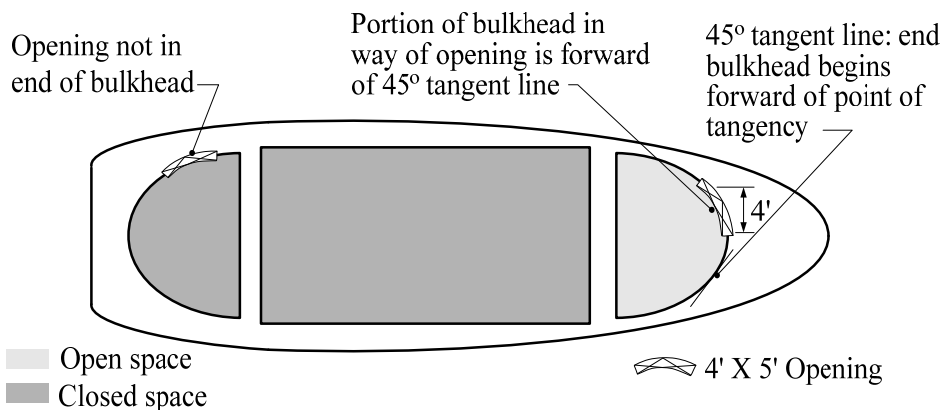

(v) Deck or Platform on Exterior Side of Opening There must be a permanent deck or platform that is a minimum of 30 inches wide on the exterior side of the opening. The deck or platform can either be solid or a grating. It must extend at least the full width of the opening, and be no more than 2 feet below the bottom edge of the opening.

(vi) Deck Height Restrictions Except as provided for in § 69.117(d)(3), if the structure has more than one compartment, only that portion of a compartment with an exterior opening or

openings meeting the requirements of this section and whose deck is no more than two feet above the associated exterior deck at the end opening(s), is considered “open to weather”.

(3) Open Space Progression to Interior Compartments A compartment within an open structure is considered open to the weather only when an interior bulkhead of that compartment has an opening or openings that meet the requirements for *openings in end bulkheads* under paragraphs (d)(2)(i) through (d)(2)(iii) of this section, *and the deck of that compartment is no more than two feet above the associated exterior deck at the end opening(s)*. Other compartments within the structure are not considered open to the weather. The following additional requirements apply:

(i) *Progression From Qualifying Openings* For the interior compartment to be considered open to the weather, any compartment or series of compartments from which the open space progresses must have an opening or openings meeting the requirements for end bulkhead openings, except that the opening(s) need not be located in the forward or after end of the compartment. *The following additional requirements apply:*

(1) Opening Location *The following requirements apply:*

(a) Interior vs. Exterior Openings *An interior bulkhead is defined as a bulkhead which is inside of the outer boundary of the structure (i.e., inboard of the outboardmost edge of the deck that covers the structure), and which does not adjoin any portion of a space which is eligible for exclusion under the provisions of § 69.61, regardless of whether or not the space is fitted with means designed for securing cargo or stores. An opening not located in an interior bulkhead is treated in a similar manner as an exterior bulkhead opening. Refer to the restrictions of § 69.117(d)(7) concerning progression of open space from excluded spaces.*

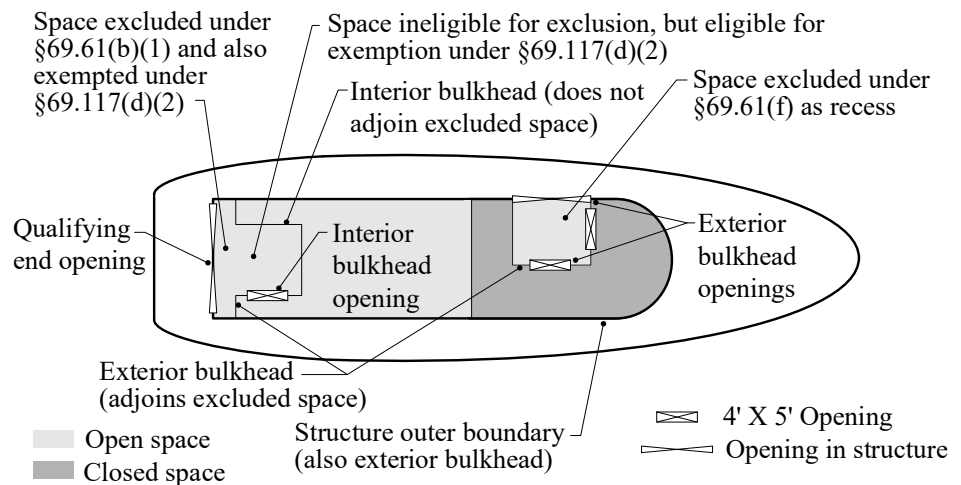

(b) Location on Bulkheads Interior bulkhead openings that otherwise meet the requirements of § 69.117(d)(2) may be installed in longitudinal as well as transverse interior bulkheads, and may be located anywhere along the bulkhead.

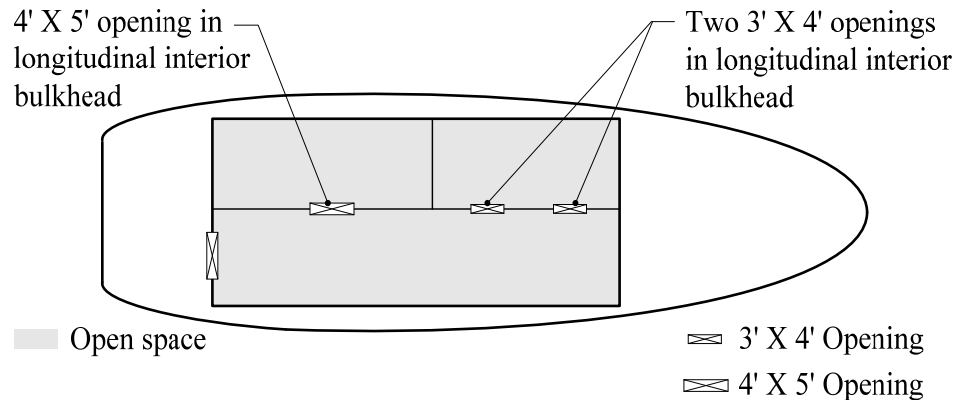

(2) Circulation Requirement The circulation requirement of § 69.117(d)(2)(i) must be met for all interior bulkhead 3' X 4' openings:

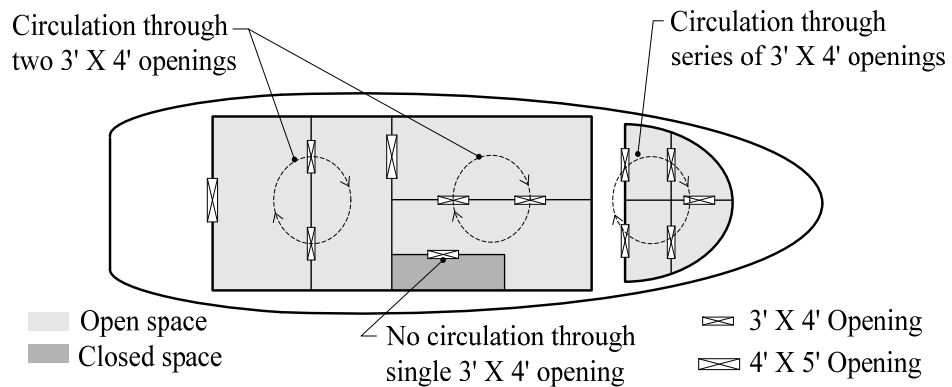

(3) Obstructions to Interior Bulkhead Openings The in the clear requirement of § 69.117(d)(2)(i) must be met for all interior bulkhead openings. As discussed in § 69.117(d)(2)(iii), obstructions within a compartment that are not within 30 inches of an opening do not affect progression of open space.

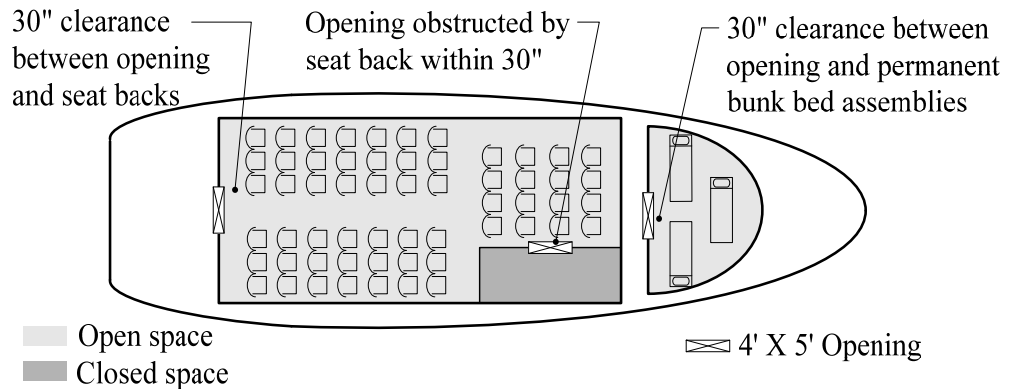

- (4) Obstructions for Openings Where Boundary Not Clearly Defined In situations where the boundary of an interior compartment is not clearly defined, the 30 inch in the clear requirement of § 69.117(d)(2)(i) is applied to an “opening” in the projected boundary established in § 69.117(d)(3)(i).

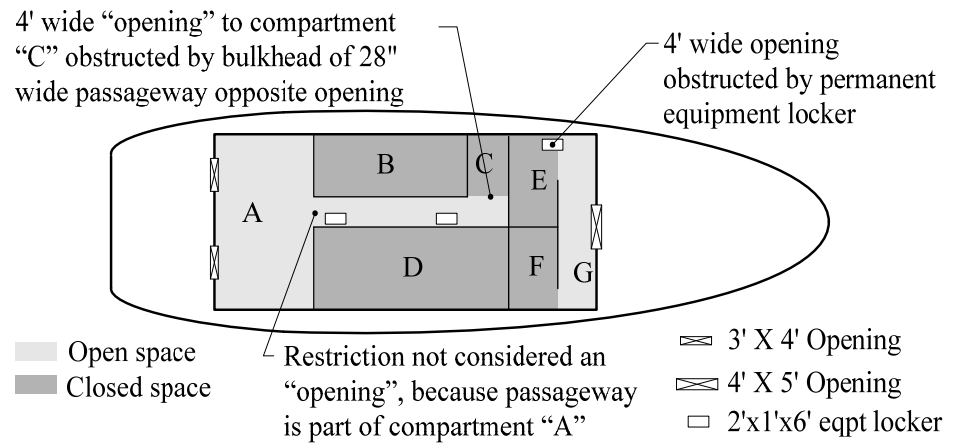

- (5) Temporary Covers for Openings In applying the requirements of § 69.117(d)(4),(5) and (6) to interior bulkhead openings, the weather side of the bulkhead is considered to be the side toward the associated exterior end bulkhead opening from the direction that the open space is progressing. In the case of 3' X 4' openings used to progress space from two different compartments, the temporary cover can be on either side of the compartment bulkhead.

- (6) Propelling Machinery Space Bulkheads There is no longer a prohibition against progression of open space through a propelling machinery space bulkhead.

- (ii) Progression of Open Space From Excluded Space Open space may not progress from a space that is open under the provisions of paragraph (d)(1)(iii) of this section unless the space may also be considered open under another provision of this section.

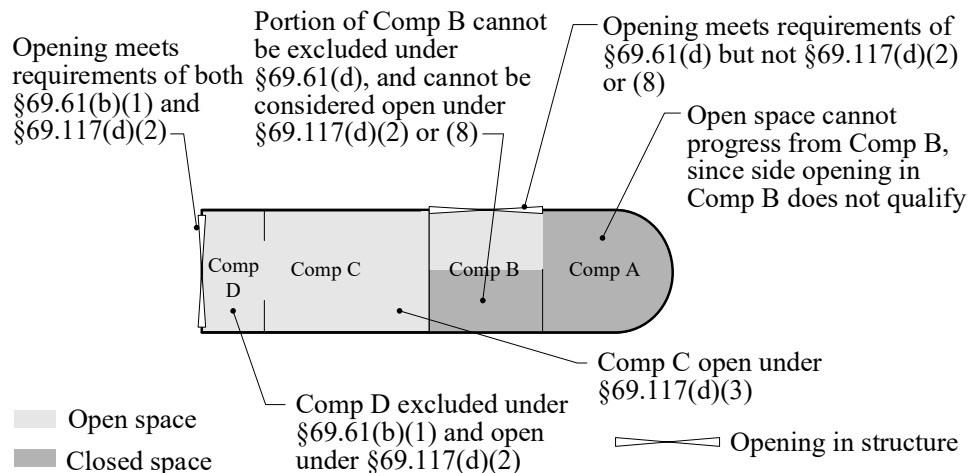

- (iii) Treatment of Bars and Similar Subspaces Partitions used to partially bound bars, serving areas, and similar subspaces within a larger compartment are not considered to be a bulkhead that subdivides the associated space into a separate compartment, provided the partition has an opening or openings into the surrounding compartment without means of closure that meet(s) the following criteria:

- (1) Opening height is at least one-third of the height of the larger compartment.
- (2) Bottom of opening is no more than 42 inches above the deck of the larger compartment at the opening.
- (3) Opening is in the clear as described § 69.117(d)(2)(i), except for the stanchions (or equivalent) necessary for the support of the deck above.
- (4) For subspaces with only one side open to the larger compartment, the opening must extend the full width or length of the larger compartment. For all other subspaces, at least two sides of the subspace must be open to the larger compartment as described in this section, with each opening extending the full width or length of the respective side.

(4) **Shifting Boards in Channels** An interior or exterior opening that is temporarily closed by shifting boards dropped into channel sections at the sides of the opening is considered open to the weather if battening, caulking, seals, or gaskets of any material are not used.

(5) **Plates/Boards With Hook Bolts** An interior or exterior opening that is temporarily closed by cover plates or boards held in place only by hook bolts (see § 69.123, Figure 12) is considered open to the weather –

- (i) **Hook Bolts** If hook bolts, “J” bolts, or “L” bolts used to secure cover plates or boards are spaced at least one foot apart and hook over a stiffener installed around the perimeter of the opening;
- (ii) **Faying** If the cover plates or boards fit tightly against the weather side of the bulkhead; and
- (iii) **Sealing** If battening, caulking, seals or gaskets of any material are not used.

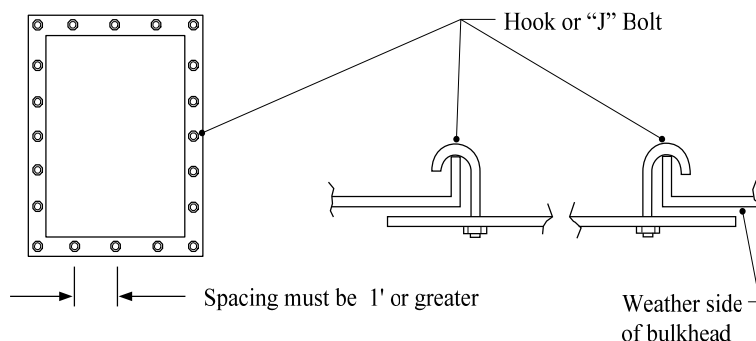

(6) **Plates/Boards With Bolts and Crosspieces** An interior or exterior opening that is temporarily closed by cover plates or boards held in place only by bolts and crosspieces (*i.e.*, “strongbacks”) is considered open to the weather –

- (i) **Bolts** If the bolts are not installed through the bulkhead. *There are no requirements on bolt spacing;*
- (ii) **Securing Devices** If the bolts and crosspieces are not held in place by cleats or other attachments to or through the bulkhead;
- (iii) **Faying** If the cover plates or boards fit tightly against the weather side of the bulkhead; and

(iv) Sealing If battening, caulking, seals or gaskets of any material are not used.

(v) Plates as Crosspieces There is nothing to preclude the use of a single backing plate or board covering the inside of the opening as a crosspiece (a so-called “sandwich” construction).

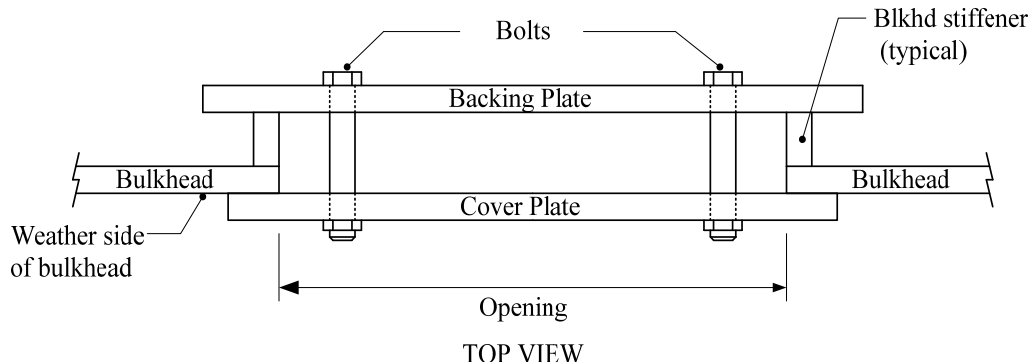

(6') Additional Requirements for Temporary Covers The following additional requirements apply to temporary covers described in § 69.117(d)(4),(5) and (6):

(i) Cover Boards and Plates Each plate or board may be composed of more than one element, which may be of different materials, though the individual elements of each plate or board must be permanently bonded together to form an integral unit. For example, trim strips on the outer edges of a cover plate must be permanently bonded to the plate in order to be considered a continuation of that plate.

(ii) Attachments and Penetrations Anything affixed to, or installed in, a temporary cover (e.g., paneling or bulkhead “plugs” attached to cover plates, insulation, doors, windows, fans, air conditioners, and fire hoses) must not: 1) be affixed to the adjoining bulkhead; 2) in any way hinder the removal of the cover; or 3) overlap the edges of the opening in any manner so as to make the cover more than non-tight. For example, a solid piece of insulation overlapping the edges of a cover plate would render the opening closed, whereas electrical equipment mounted on a cover plate but plugged into a wall receptacle on the bulkhead would not.

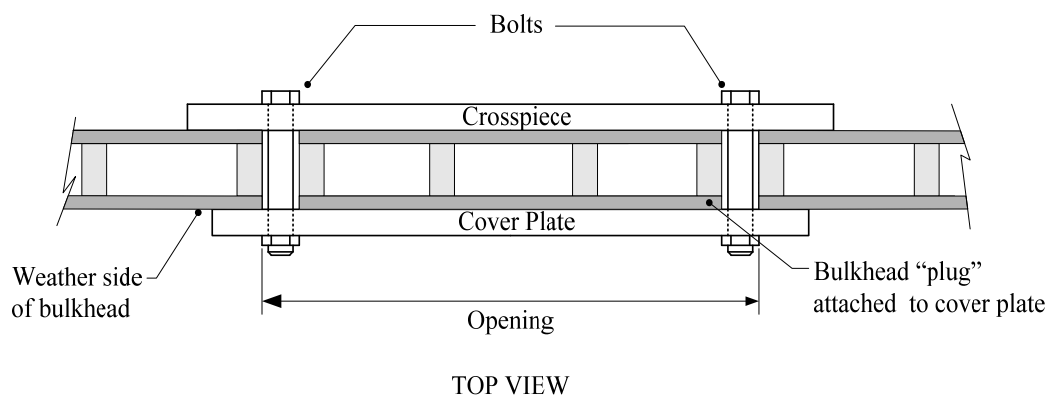

(iii) Cover Fasteners Fasteners used to hold cover plate(s) or board(s) in place must be designed such that removal of the fasteners causes the associated plates(s) or board(s) to “fall free”. The fasteners must be completely accessible to the extent that the plate can be readily removable at all times; otherwise, the associated opening is considered closed. Anything used to “hide” the portions of the fasteners to which access is required must be of a temporary nature as described in § 69.117(d)(2')(i), and must be attached only to the cover plate(s), board(s) or crosspiece(s).

(iv) Reserved

(v) Alternate Covers In addition to the temporary covers described in § 69.117(d)(4),(5) and (6), wire mesh or a flexible fabric-like material (such as canvas) may be applied to an otherwise uncovered opening without closing the opening. Framing, cleats, battens or cross braces, if used to secure the wire mesh or fabric, must not interfere with the in the clear requirement for the opening as described in § 69.117(d)(2')(i). **NOTE: No other alternate covers are authorized. This includes sliding doors, hinged doors, and expandable partitions installed across otherwise qualifying openings, even if the item clears the opening when in the open position and/or can be easily removed.**

(vi) Impact on Vessel Safety As is the case with other tonnage reduction features, it is the responsibility of the designer/owner/operator to ensure that safety aspects of temporary covers are carefully evaluated. For example, an opening cannot be made to be watertight using temporary covers described in § 69.117(d)(4),(5) or (6) and, therefore, could compromise a vessel's watertight integrity. For fire protection of temporary covers, refer to the requirements of Navigation and Vessel Inspection Circular (NVIC) 9-97, Guide to Structural Fire Protection.

(7) **Structures Entirely Open From Aft End** Notwithstanding the opening size requirements of paragraph (d)(2) of this section, a structure with its aft end entirely open from the under side of its overhead stiffeners down to the deck, to the line of the deck, or to a coaming not exceeding three inches in height and open athwartships between the inboard faces of the side stiffeners is considered open to weather. The opening may be covered by a wire mesh screen or temporarily closed by a flexible fabric-like material (such as canvas) secured at the top and lashed or buttoned in place. Open space may progress from a compartment open from the aft end to another compartment, provided the requirements of § 69.117(d)(3) for progression of open space within a structure are met.

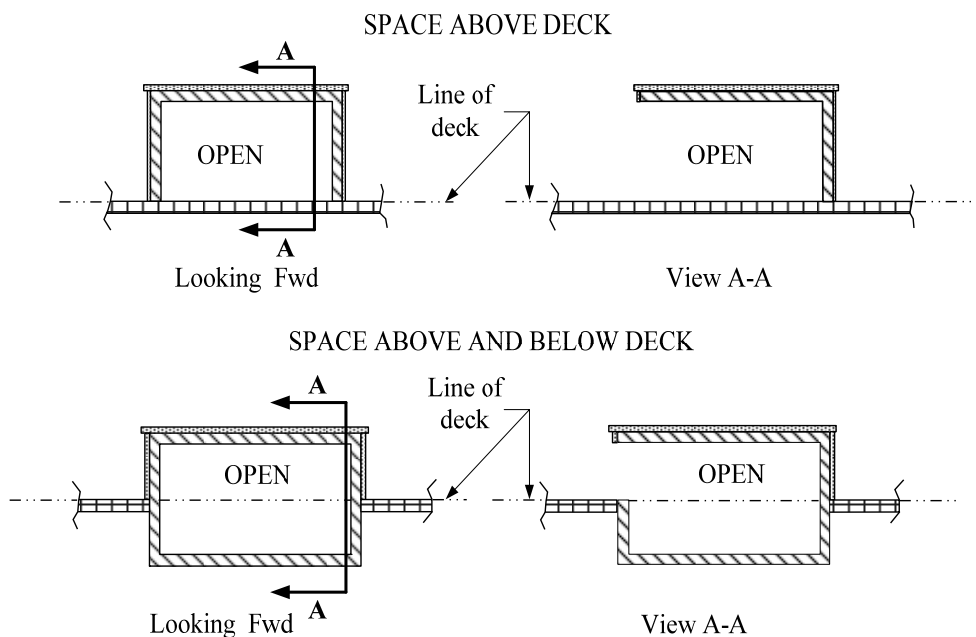

(8) **Opposite Side Openings** A structure is considered open to the weather if--:

- (i) **Closures** Both sides of the structure are open and not fitted with any means of closing other than temporary covers meeting the requirements of paragraphs (d)(4), (d)(5), and (d)(6) of this section;
- (ii) **Clear Openings** The openings are directly across from each other, are not separated by a bulkhead or bulkheads, and do not have any permanent obstruction within two and one-half feet of either opening;

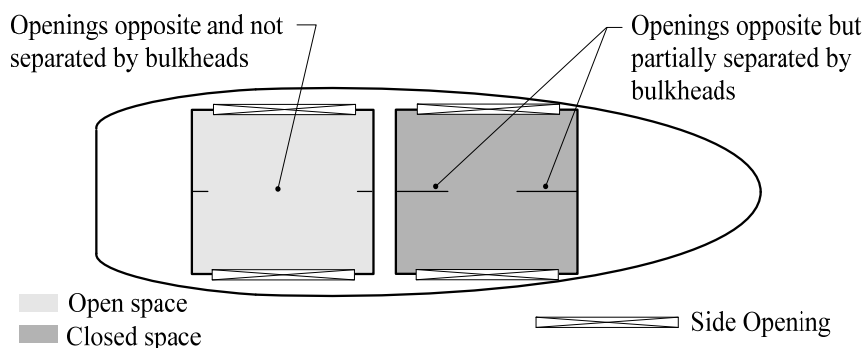

- (iii) **Opening Height** The openings have a continuous height of at least three feet, or the full height of the structure, whichever is less, and either extend the full length of the structure or each have an area of 60 square feet. *Where a 3 foot minimum height is specified, the minimum height must be maintained throughout the entire length of the opening (e.g., the height cannot be infringed on by rounded corners);*
- (iv) **Combinations of Openings** *When a combination of openings on each side are used to meet minimum area requirements, the openings cannot be separated from the adjacent opening(s) by any more than the stanchions (or equivalent) necessary to support the overhead deck covering.*
- (v) **Progression of Open Space** *Open space will progress from a compartment open to the weather using opposite side openings to another compartment, provided the requirements of § 69.117(d)(3) for progression of open space within a structure are met.*

(e) Open Space Between the Shelter Deck and the Uppermost Complete Deck

- (1) **General** Space that is between the shelter deck and the uppermost complete deck and that is under cover (sheltered) but open to the weather is exempt from tonnage when all openings in the uppermost complete deck are provided with a watertight means of closing. *Associated scuppers cannot be submerged under any loading condition if open space is to be exempt from gross tonnage under this section.*
- (2) **Requirements for Middle Line Openings** A space is considered “open to the weather” under paragraph (e)(1) of this section when the shelter deck above the space has a middle line opening which conforms to the following:
 - (i) **Size and Shape** The middle line opening must be at least four feet long in the clear and at least as wide as the after cargo hatch on the shelter deck, but not less than one-half the width of the vessel at the midpoint of the length of the opening. The opening may have rounded corners not exceeding a nine inch radius. When a greater radius is required by the Coast Guard or a

Coast Guard recognized classification society under §42.05-60 of this chapter, notification of that requirement must be submitted to the Commandant (*Marine Safety Center*).

- (ii) Longitudinal Position The middle line opening must be located so that the distance between the aft edge of the middle line opening and the vessel's stern is not less than one-twentieth of the tonnage length of the vessel and the distance between the fore edge of the opening and the vessel's stem is not less than one-fifth of the tonnage length of the vessel.
 - (iii) Enclosing Structures The middle line opening must not be within a structure of any type.
 - (iv) Railings and Stanchions If the middle line opening is guarded by rails or stanchions, the rails and stanchions must not be used to secure or assist in securing a cover over the opening.
 - (v) Coamings and Covers The coaming of the middle line opening must not exceed one foot mean height above the shelter deck. Bolts must not pass through the stiffeners or flanges on the coaming, nor may there be any other attachments on the coaming for fastening a cover. Portable wooden covers may be fitted over the middle line opening if held in place only by lashings fitted to the under side of the covers. Metal covers may be fitted if held in place only by hook bolts spaced not less than 18 inches apart that pass through the cover and hook over angle stiffeners or flanges fitted to the outside of the coaming. Battening, caulking, seals, or gaskets of any material may not be used in association with any middle line opening cover.
 - (vi) Space Below Opening The space below the middle line opening must have a minimum length of four feet throughout its entire breadth and height and be in the clear at all times.
 - (vii) Scupper Requirements A scupper having a five inch minimum inside diameter and fitted with a screw down non-return valve geared to and operated from the shelter deck must be fitted on each side of the uppermost complete deck in way of the middle line opening.
- (3) **Middle Line Openings and 3 X 4 Foot Tonnage Openings** When the shelter deck space forward or aft of the middle line opening is divided by interior bulkheads, only those compartments with at least two openings that progress to the middle line opening are considered "open to the weather" under paragraph (e)(1) of this section. Each required opening must be at least three feet wide and at least four feet high in the clear, must not have a coaming height of more than two feet, and must not be fitted (except as provided in paragraphs (d)(4), (d)(5) and (d)(6) of this section) with any means of closing. Other compartments within the shelter deck space are not considered "open to the weather" under paragraph (e)(1) of this section.
- (f) **Water Ballast Spaces**
A space, regardless of location, adapted only for water ballast and not available for stores, supplies, fuel, or cargo (other than water to be used for underwater drilling, mining, and related purposes, including production), upon request, may be exempt from tonnage if the following are met.
- (1) **Available Only For Water Ballast** The space must be available at all times only for water ballast that is piped through a system independent of other systems (except fire fighting and bilge suction systems). Pumps, pipes, and other equipment for loading and unloading water ballast must be of a size suitable for the efficient handling of the water ballast within a reasonable time frame.
- Manhole Requirements** All manholes providing access to a water ballast space must be oval or circular and not greater than 34 inches in diameter. Except for those on a deck exposed to the weather, the manholes may have a coaming not exceeding six inches in height.

Hatch Requirements Existing hatches over spaces being converted to water ballast spaces must have a water tight cover plate welded to the hatch and a manhole, as described in this paragraph, fitted in the plating.

- (2) **Purpose of Water Ballast** The primary purpose of the water ballast must be to afford a means of maintaining the vessel's stability, immersion, trim, pre-loading conditions, or seakeeping capabilities.
- (3) **Relation to Stability Analysis** If the space is in a vessel that is subject to inspection under 46 U.S.C. 3301, the space must be considered when determining the adequacy of the vessel's stability under 46 CFR chapter I.
- (4) **Water Ballast Justifications** If the total of all water ballast spaces to be exempted from tonnage exceeds 30% of the vessel's gross register tonnage (as calculated under this subpart without any allowance for water ballast), a justification of the operating conditions that require the water ballast must be submitted to the measuring organization for approval. Although a single condition may justify all water ballast spaces, several conditions may be necessary in other cases. However, a particular tank is not justified by a condition if another tank already justified by another condition could be used as effectively. The justification must -
 - (i) Designate the vessel's service;
 - (ii) Explain for what purpose under paragraph (f)(2) of this section the water ballast is being used;
 - (iii) Include the capacity, tank arrangement, and piping plans for the vessel;
 - (iv) Include a statement certifying that the space will be used exclusively for water ballast as prescribed by this section;
 - (v) If water ballast is used for stability, describe each loading condition and the resultant metacentric height (GM) and include calculations;
 - (vi) If water ballast is used for immersion or trim, describe those conditions and include loading and trim calculations;
 - (vii) If water ballast is used for preloading, describe how it is used and include strength and weight calculations; and
 - (viii) If water ballast is used for seakeeping, describe each loading condition, GM, period of roll, and, if speed is involved, speed versus trim and draft and include calculations.
- (5) **Reporting of Changes** If the water ballast space or its use, purpose or piping are changed, the vessel owner or operator must report the change promptly to a measurement organization listed in § 69.15 for a determination as to whether a tonnage measurement is required. Changes in vessel service must also be reported if a water ballast justification was required to be submitted for the vessel.

(g) Methods for Measuring Exempt Spaces

- (1) **Superstructure** If the exempt space is located within the superstructure, the exempt space is measured using the same procedures used to measure superstructure tonnage under § 69.113.
- (2) **Between-Deck** If the exempt space is located between-deck, the space is measured using the same procedures used for between-deck tonnage under § 69.111(c), except that the length of the exempt space is divided into the even number of spaces most equal to the number of spaces into which the between-deck was divided, giving a common interval most nearly equal in length to that used in calculating the between-deck tonnage.
- (3) **Under-Deck** If the exempt space is located under-deck, the space is measured using the same procedures used for under-deck tonnage under § 69.109, except that the length of the exempt space is divided into the even number of spaces most equal to the number of spaces into which the under-deck was divided, giving a common interval most nearly equal in length to that used in calculating the under-deck tonnage, and the zone of influence method must be applied if the ordinary frames upon which the under-deck breadth measurements are based do not have the same depth of frame. *In all cases, the tank's tonnage length is taken as the longitudinal distance between the extreme ends of the tank, exclusive of any portion of the tank fore/aft of the respective under-deck tonnage length termination points. In applying this procedure to a tank that consists of a series of contiguous but distinct spaces of varying shapes and sizes, the volume of each distinct space is calculated separately, rather than treating the distinct spaces within the tank as a single tank.*

(i) Show Tank and Under-Deck Stations Develop a plan view or side profile, showing the tank stations and the under-deck tonnage stations.

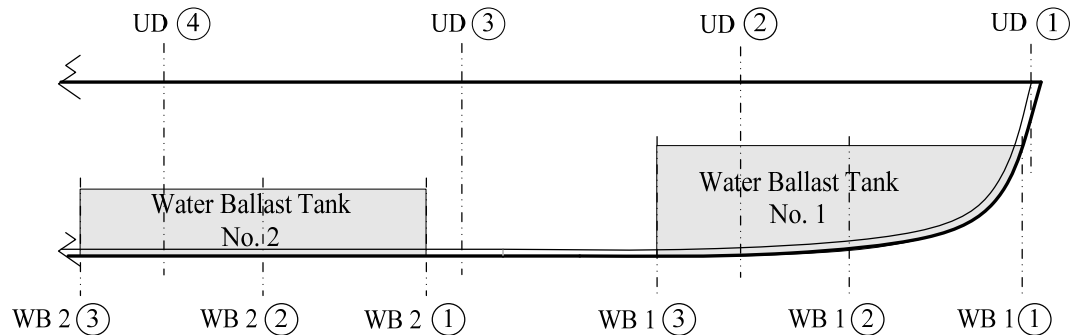

(ii) Lay Out Zones of Influence On this plan view or side profile, lay out zones of influence around each under-deck tonnage station. The zones of influence are as follows, depending on the Simpson's first rule multiplier for the associated under-deck tonnage station:

Simpson's Multiplier	Length of Zone of Influence
1	One 1/3 common interval
2	Two 1/3 common intervals
4	Four 1/3 common intervals

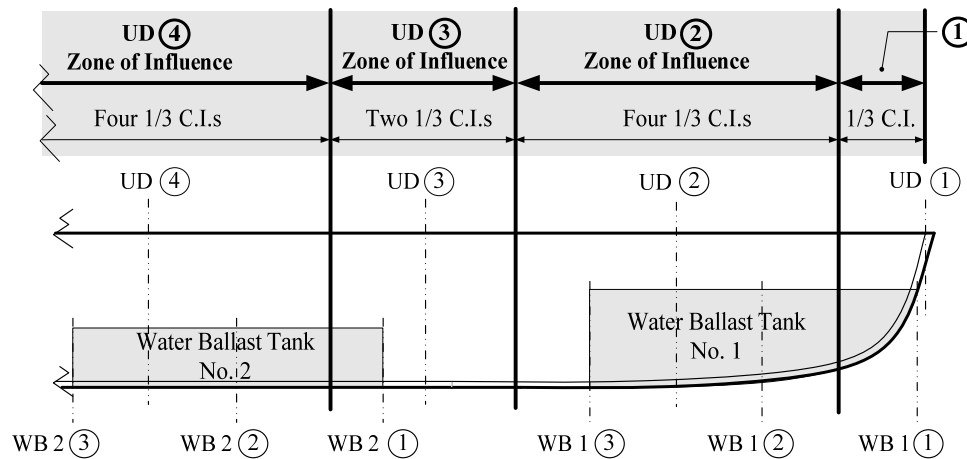

(iii) Identify Associated Under-Deck Tonnage Stations For each tank station, identify the under-deck tonnage station under whose "zone of influence" the tanks station falls. In cases where the tank terminates precisely at the boundary between two zones of influence, chose the zone of influence that will yield the largest tank sectional area under step (iv) below.

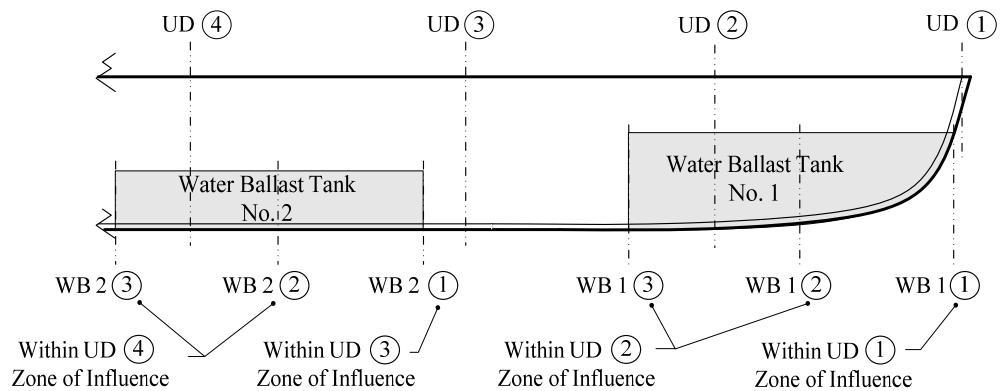

(iv) Superimpose Tank Sections on Under-Deck Sections Superimpose (project) the outline of each complete tank section (i.e., to the skin of the tank) onto the associated under-deck tonnage section at the under-deck tonnage station identified in step (iii) above. Then, for each tank station, calculate the tank sectional area by applying Simpson's first rule to the portion of the tank that is inboard of the line of the ordinary frames of the under-deck section.

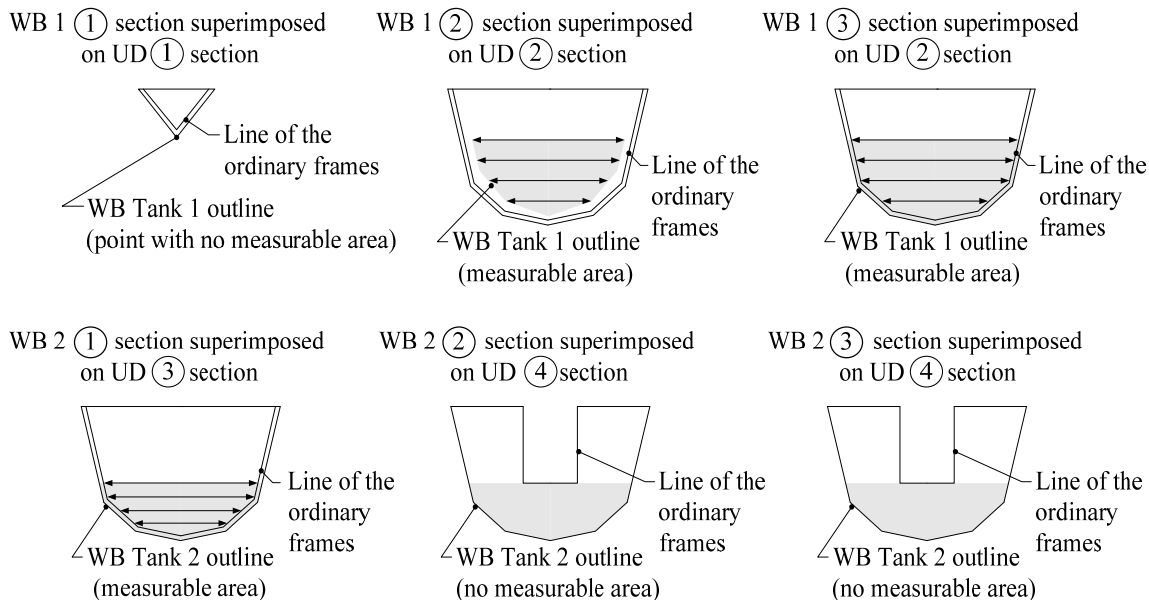

(v) Perform Longitudinal Integration Perform a longitudinal integration using the tank's "tonnage" length, and the sectional areas calculated in step (iv) above. The resulting tank volume is converted to tonnage using the procedures of § 69.109.

§ 69.119 SPACES DEDUCTED FROM GROSS TONNAGE

(a) Purpose

This section lists the requirements for spaces (other than propelling machinery spaces under § 69.121), which, though included in calculating gross register tonnage (i.e., are not exempt under § 69.117), are deducted from tonnage in deriving net register tonnage.

(b) General

The following general requirements apply for spaces to be deducted from gross tonnage:

- (1) **General Restrictions** A deductible space must be used exclusively for, and be reasonable in size for, its intended purpose.
- (2) **Working Space** When a space is larger than necessary for the safe and efficient operation of deductible equipment, only the space occupied by the equipment plus a two foot maximum working space on each side of the equipment, if available, is deductible.
- (3) **Location** Space specified in this section may be located anywhere within the vessel, unless otherwise specified.
- (4) **Optional Deduction** The deduction of any space under § 69.119 is at the option of the vessel's owner, but is predicated on the proper marking of the space in accordance with §69.119(p).

(c) Anchor Gear

A space below the line of the uppermost complete deck, occupied by the anchor gear, capstan, windlass, and chain locker is deductible. A fore peak used exclusively as a chain locker is measured by the method prescribed under § 69.117(g)(3).

(d) Boatswain's Stores

A space containing oils, blocks, hawsers, rigging, deck gear, or other boatswain's stores for daily use is deductible. The maximum deduction allowed for vessels less than 100 gross tons is one ton and, for vessels 100 gross tons or over, is one percent of the gross tonnage, not to exceed 100 tons.

(e) Chart Room

A space for keeping charts and nautical instruments and for plotting the vessel's course is deductible. For a combined wheelhouse and chart room, that part not exempted as wheelhouse under § 69.117(b)(9) is deductible. For small vessels in which the only space for a chart room is in a cabin or saloon, one half the space not to exceed 1.5 tons is deductible as chart room.

(f) Donkey Engine and Boiler

Donkey engine and boiler space is deductible when connected with the main (non-cargo) pumps of the vessel, except as follows. *A donkey engine is an auxiliary engine that is not directly used for propelling the vessel, and the main pumps are pumps which are solely used for handling ballast water, feed and condensate water, or water used for deck washdown or other cleansing purposes, as well as for removal of water that has entered the holds, bilges and similar.*

(1) Space within Engine Room or Casing If the space is within the engine room or within the casing above the engine room and if the donkey engine is an auxiliary to the main propelling machinery, the space is an engine room deduction under § 69.121(b).

(2) Space above Uppermost Complete Deck If the space is above the line of the uppermost complete deck and if the donkey engine is not an auxiliary to the main propelling machinery, the space is exempt under § 69.117(b)

(g) Spaces for the Exclusive Use of Officers or Crew

This section provides minimum requirements for deductible spaces that are for the exclusive use of officers or crew.

(1) Miscellaneous Officer/Crew Spaces The following spaces, regardless of their location (unless otherwise noted), are deductible if not used by passengers:

(i) Sleeping rooms

(ii) Bathrooms with a bath tub or shower but without a water closet

(iii) Water closets below the line of the uppermost complete deck serving more than one person, with or without a bath tub or shower. Water closets, regardless of location, that serve only one person or that are accessible only through a stateroom or bedroom serving one person are considered as part of the space they serve and are deductible only if that space is deductible.

(iv) Clothes drying rooms

(v) Drinking water filtration or distilling plant below the line of the uppermost complete deck.

(vi) Hospitals

- (vii) Mess rooms
 - (viii) Office of the Chief Engineer
 - (ix) Oil skin lockers
 - (x) Pantries
 - (xi) Recreation rooms
 - (xii) Smoking rooms
 - (xiii) Galleys below the line of the uppermost complete deck.
- (2) **Shops** Shops for engineers, carpenters, plumbers, or butchers and offices for clerks, pursers, or postmasters are not deductible, wherever located.
- (h) **Master's Cabin**
The master's sleeping room, dressing room, bathroom, observation room, reception room, sitting room, water closet, and office are deductible.
- (i) **Radio Room**
Spaces in which radio apparatus is installed and messages are sent and received and which may provide off-duty operator accommodations are deductible.
- (j) **Steering Gear**
Spaces for steering gear below the line of the uppermost complete deck are deductible.
- (k) **Generators**
Spaces for generators below the line of the uppermost complete deck are deductible regardless of what space the generators serve. These spaces may include other equipment necessary for the generator's operation.
- (l) **Pump Room**
Spaces below the line of the uppermost complete deck *in a room* containing pumps that are not capable of handling cargo and that are not fuel oil transfer pumps considered part of the propelling machinery under § 69.121(b)(2)(v) are deductible. *A pump room containing both a pump and its prime mover (e.g., motor or engine) is ineligible for deduction as a pump room under this section, unless the pump is not capable of handling cargo and the prime mover is a donkey engine.*
- (m) **Sail Stowage**
A space for stowing sails on a vessel propelled only by sails is deductible up to two and one-half percent of the vessel's gross tonnage.
- (n) **Waste Material Space**
- (1) **Storage Spaces** A tank or collection space, regardless of location, used for the carriage or collection of sewage, garbage, galley waste, trash, slop-oil mixture, tank cleaning residue, bilge residue, or other waste material generated aboard the vessel is deductible.
 - (2) **Processing Spaces** Space below the line of the uppermost complete deck used exclusively to separate, clarify, purify, or otherwise process waste material generated aboard the vessel is deductible.

(o) Passageways

A passageway or companionway is deductible -

- (1) If it serves deductible spaces only; or
- (2) If it serves deductible and exempted spaces and is also the sole means of access to one of the following non-deductible spaces:
 - (i) Lockers of less than two tons each, containing medicine, linen, mops, or other items for the free use of the crew.
 - (ii) A ship's office.
 - (iii) Spare rooms (not exceeding two) used by a pilot, customs officer, reserve engineer, or employee or agent of the vessel's owner or operator.

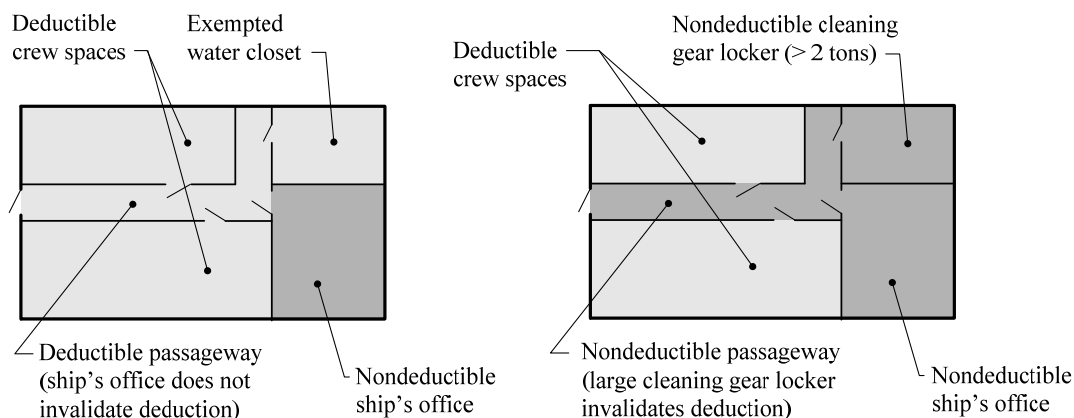

(p) Markings for Deductible Spaces

This section provides general requirements for marking of deductible spaces.

- (1) **General** Each space deducted under this section must be marked with the words “Certified _____” (inserting the space designation, such as “Seaman”, “Generator”, “Office of Chief Engineer”, “Hospital”, or “Anchor Gear”). If a deductible space berths more than one crew member, the marking must indicate the number of crew members berthed, such as “Certified _____ Seaman” (inserting the number of crew).
- (2) **Abbreviations** The abbreviations “Cert.” for “certified” and “W.C.” for “water closet” may be used.
- (3) **Lettering** The markings must be in Roman letters and Arabic numerals at least 1/2 inch in height, must be painted in a light color on a dark background, must be embossed, center-punched, carved, or permanently cut in a bulkhead or metal plate, and must be placed in a legible location over a doorway on the inside of the space. A metal plate, if used, must be permanently fastened in place by welding, riveting, lock screws, or a Coast Guard-approved bonding agent.

(q) Method for Measuring Deductible Spaces

This section provides general requirements for measuring deductible spaces.

- (1) **Rectangular Spaces** A rectangular space must be measured by taking the product of its length, breadth, and height.

- (2) ***Spaces with Curved Sides Above Tonnage Deck*** A space with curved sides on or above the tonnage deck is measured according to § 69.109.
- (3) ***Spaces Less Than 15 Feet Long*** Space less than 15 feet in length may be measured by any practical method.
- (4) ***Spaces with Curved Sides Below Tonnage Deck*** Spaces below the tonnage deck exceeding 15 feet in length and bounded by a curved surface conforming to the side of the vessel must be measured by the formula used for measuring the superstructure under § 69.113.
- (5) ***Spaces on Platforms*** The height of a space located on a platform in the hull must be measured from the top of the bottom hull frames, if the platform is used only to form a flat surface at the bottom of the space, if the platform is not more than one foot above the top of the bottom frames, and if the space below the platform is not usable.
- (6) ***Treatment of Ceiling*** The height of a space is measured through any ceiling, paneling, false overhead, or other covering, to the space's structural boundary, unless the space enclosed by the covering is available for a non-deductible use.
- (7) ***Measurement Adjustments*** *Adjust measurements to ensure deduction of only those spaces, or portions thereof, whose volumes are included in calculating the gross register tonnage by applying the zone of influence method, subtracting volumes of portions of spaces that are outside the line of the ordinary frames or otherwise ineligible for deduction, or similar methods as authorized by the Marine Safety Center.*

§ 69.121 ENGINE ROOM DEDUCTION

(a) General

The engine room deduction is either a percentage of the vessel's total propelling machinery spaces or a percentage of the vessel's gross register tonnage.

(b) Propelling Machinery Spaces

- (1) **General** Propelling machinery spaces are the spaces occupied by the main propelling machinery and auxiliary machinery *used in connection with propelling the vessel*, and spaces reasonably necessary for the operation and maintenance of the machinery. Propelling machinery spaces do not include spaces for fuel tanks, spaces exempt from tonnage under § 69.117, and spaces not used or not available for use in connection with propelling machinery.

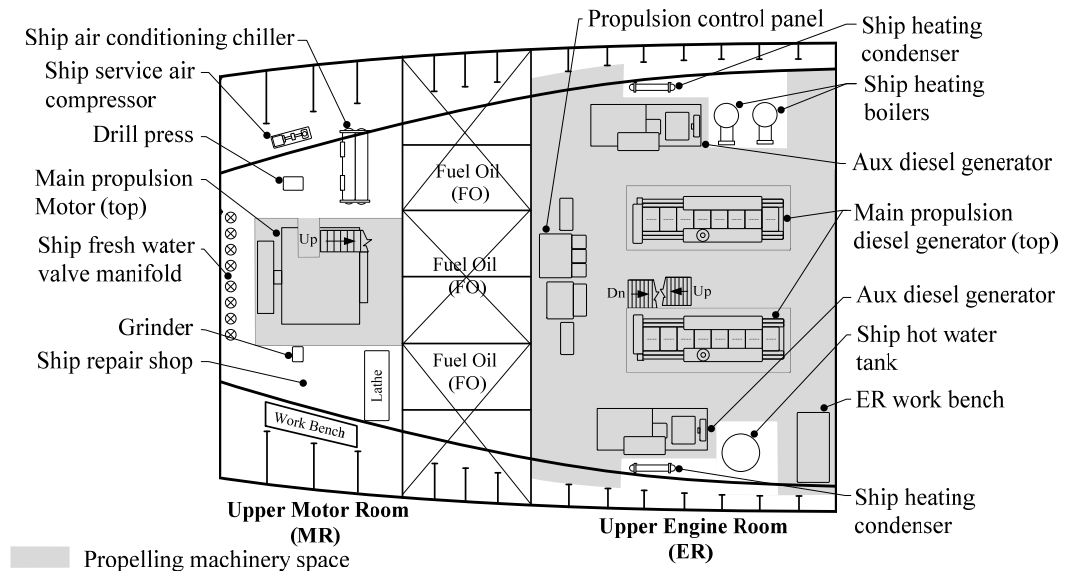

- (2) **Specific Spaces** Propelling machinery spaces are -

- (i) **Space Below the Crown.** The crown is the top of the main space of the engine room to which the heights of the main space are taken. The crown is either the underside of a deck or, if the side bulkheads are sloping, the uppermost point at which the slope terminates. (See §69.123, figures 13 and 14.)
- (ii) **Space Between the Crown and Uppermost Complete Deck** Framed-in space located between the crown and the uppermost complete deck and used for propelling machinery or for the admission of light or air to propelling machinery spaces. (See §69.123, figures 13 and 14.)
- (iii) **Shaft Tunnel and Thrust Block Recess** Shaft tunnel space and thrust block recess space.
- (iv) **Escape Shafts and Trunks** Space below the uppermost complete deck used for escape shafts or trunked ladderways leading from the aft end of the shaft tunnel to the deck above.
- (v) **Fuel Oil Transfer Pumps** Space containing a fuel oil transfer pump located in a separate space and not used for bunkering the vessel. When the pump serves both ballast and fuel oil, only one-half of the pump's space is considered a propelling machinery space.
- (vi) **Fuel Oil Settling Tanks** Spaces containing fuel oil settling tanks used solely for the main boilers. The space must not exceed one percent of the vessel's gross tonnage.
- (vii) **Engineer's Stores and Workshops** Spaces for engineers' stores and workshops located below the uppermost complete deck and either open to a propelling machinery space or

separated from a propelling machinery space only by a screen bulkhead. The space must not exceed three-quarters of one percent of the vessel's gross register tonnage.

(viii) **Space Above Line of Uppermost Complete Deck** Framed-in space located above the line of the uppermost complete deck and used for propelling machinery or for the admission of light or air to a propelling machinery space, when requested under paragraph (d) of this section.

(ix) **Boxed-In Machinery** If the propelling machinery is boxed-in below the tonnage deck, the boxed-in spaces plus the spaces outside of the boxing for the shaft, auxiliary engines, and related propelling machinery. If a portion of the boxed-in space extends above a platform or partial deck that is below the uppermost complete deck, or line thereof, that portion below the line of the uppermost complete deck, or line thereof, is also considered part of the propelling machinery space, and the remainder is exempt as light or air space (see §69.117(4)(iv)). In this context, the term "boxed-in" refers to housings or similar non-framed-in protective coverings, typically fitted on engines in the open cockpit of motorboats or similar small craft.

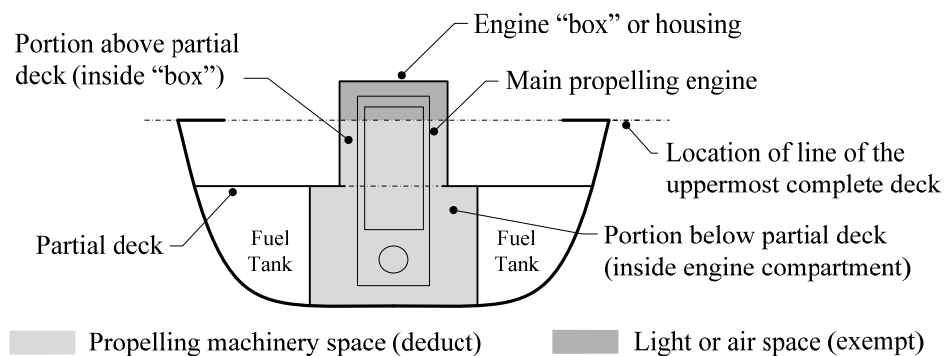

(c) **Methods for Measuring Propelling Machinery Spaces**

This section provides requirements for measuring propelling machinery spaces.

- (1) **Measure Entire Space** If the propelling machinery space is not larger than necessary for the safe operation and maintenance of the propelling machinery, the entire space, is measured for the engine room deduction.
- (2) **Measure Machinery Plus Working Space** If the propelling machinery space is larger than necessary for the safe operation and maintenance of the propelling machinery, only the space occupied by the propelling machinery itself plus a working space of two feet, if available, on each side of the propelling machinery is measured for the engine room deduction. If the working space overlaps another working space not related to the propelling machinery, only one-half of the overlapping working space is included in the propelling machinery space. The height of the working space is measured as provided in paragraph (c) of this section.
- (3) **Multiple Locations** If the propelling machinery is located in more than one space, each space must be measured separately.
- (4) **Measurement in Parts** If the propelling machinery is located in a space with a step in the bottom or side lines, each stepped portion of the space must be measured separately.
- (5) **Length Measurement** The length of a space under paragraph (c)(1) of this section is measured from the bulkhead just forward of the propelling machinery to the bulkhead just aft of the propelling machinery. The length of a space under paragraph (c)(2) of this section is measured from the forward edge of the working space to the aft edge of the working space.

- (6) **Rectangular Boundaries** If the boundaries of the propelling machinery space form a rectangle, the product of the length, breadth, and height, divided by 100, is the tonnage of the space.
- (7) **Continuous Fair Lines** If the boundaries of the propelling machinery space are continuous fair lines, heights are measured at the fore and aft ends and at the center of the space from *the line of the ordinary* bottom frames, floors, or tank top of a double bottom (*water ballast*) up to the line of the crown. A breadth is measured at half-height of each height. The product of the length, mean breadth, and mean height, divided by 100, is the tonnage of the space.

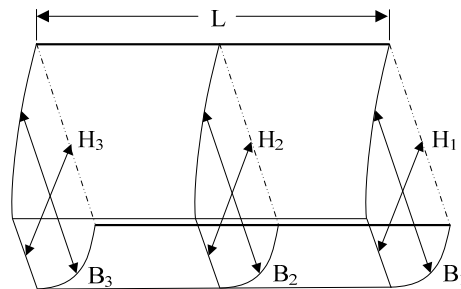

$$\text{Tonnage}_{PM} = \left(\frac{L \times B_{avg} \times H_{avg}}{100} \right)$$

where:

$$B_{avg} = \left(\frac{B_1 + B_2 + B_3}{3} \right)$$

$$H_{avg} = \left(\frac{H_1 + H_2 + H_3}{3} \right)$$

- (8) **Aft End Hull** If the propelling machinery space is in the *extreme* aft end of the hull, extends from side to side of the hull, and has a continuous bottom *and* side line, the length of the space is divided into the even number of equal parts most nearly equal to the number of parts that the tonnage length under § 69.109(g) was divided, *giving a common interval most nearly equal in length to that used in calculating the under-deck tonnage*. The tonnage is then calculated by the same method used for calculating the under-deck tonnage in § 69.109(l). *Alternatively, and at the vessel owner's request, the method of § 69.121(c)(7) may be used, provided the boundaries of the propelling machinery space are continuous fair lines.*

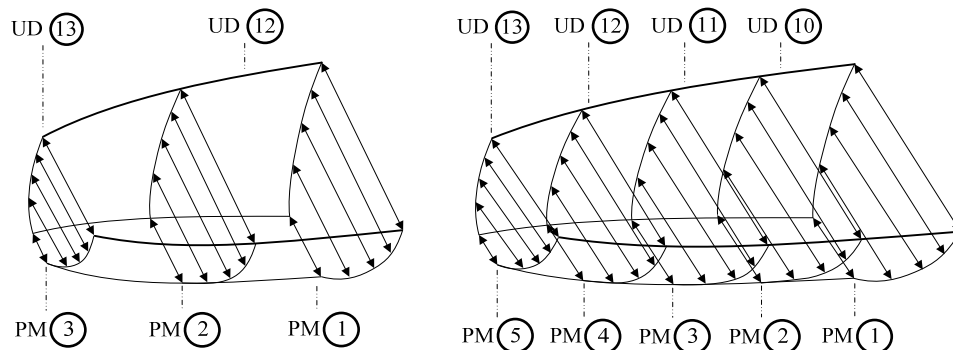

- (9) **Between Crown and Uppermost Complete Deck** The tonnage of a framed-in space located between the crown and the uppermost complete deck and used for propelling machinery or for the admission of light or air to the propelling machinery space, is the product of its length, breadth, and height, divided by 100.
- (10) **Cased Shaft Tunnel and Thrust Block Recess** The tonnage of a shaft tunnel, or a thrust block recess, having a flat top is the product of its length, breadth, and height, divided by 100. If the shaft tunnel or thrust block recess top is not flat, the space above must be calculated by using the appropriate geometrical formula. If the space aft of the shaft tunnel extends from side to side of the vessel, the tonnage of the space is found by the formula for measuring peak tanks in § 69.109(l).

- (11) **Uncased Shaft Tunnel and Thrust Block Recess** The length and breadth of the space for the shaft tunnel, or a thrust block recess, when not cased is that which is necessary for maintenance of the shaft. The height allowed for thrust block recess space must not exceed seven feet. The mean height allowed for the shaft tunnel space must not exceed six feet. In a multi-screw vessel where the shaft tunnel or thrust block recess space is open from side to side, measure only the space used for purposes of propelling the vessel.
- (12) **Propelling Machinery Bed** When the propelling machinery is on a bed at the vessel's bottom which is above the line of the ordinary frames, the height of the propelling machinery space is measured from the top of the bottom frames or floors (i.e., the line of the ordinary frames).
- (13) **Measurement Adjustments** Adjust measurements to ensure deduction of only those spaces, or portions thereof, whose volumes are included in calculating the gross register tonnage by applying the zone of influence method, subtracting volumes of portions of spaces that are outside the line of the ordinary frames or otherwise ineligible for deduction, or similar methods as authorized by the Marine Safety Center.
- (d) **Engine Room Spaces Above Line of the Uppermost Complete Deck**
Spaces meeting the specific requirements below may also be deducted as propelling machinery space. Requests to treat certain framed-in engine room spaces as part of a propelling machinery space must be submitted in accordance with paragraph (1) below.
- (1) **Optional Deduction of Otherwise Exemptible Space** Under § 69.117(b)(4), framed-in spaces located above the line of the uppermost complete deck and used for propelling machinery or for admitting light or air to a propelling machinery space are exempt from inclusion in tonnage. However, upon written request to a measurement organization listed in § 69.15, the vessel owner may elect to have these spaces included in calculating gross register tonnage, then deducted from gross register tonnage as propelling machinery spaces under paragraph (b)(2)(viii) of this section when calculating the net register tonnage.
- (2) **Restrictions** The framed-in space must be safe, seaworthy, and used only for propelling machinery or for the admission of light or air to the propelling machinery space. The length of the space must not exceed the length of the propelling machinery space and the breadth must not exceed one-half of the extreme inside midship breadth of the vessel. Portions of the framed-in space that are plated over are not included in the propelling machinery space.
- (3) **Maximizing Engine Room Deduction** To exercise the option in paragraph (d)(1) of this section, all of the framed in space need not be treated as propelling machinery space, but only that portion required to entitle the vessel to have 32 percent of its gross register tonnage deducted as an engine room deduction under paragraph (e) of this section.
- (e) **Calculating the Engine Room Deduction**
- (1) **General** The engine room deduction is based on a percentage of the vessel's gross register tonnage or a percentage of the total propelling machinery space.
- (2) **Vessels Propelled by Screw** For vessels propelled in whole or in part by screw -
- (i) If the total propelling machinery space is 13 percent or less of the vessel's gross register tonnage, deduct 32/13 times the total propelling machinery space;
- (ii) If the total propelling machinery space is more than 13 but less than 20 percent of the vessel's gross register tonnage, deduct 32 percent of the vessel's gross register tonnage; or

- (iii) If the total propelling machinery space is 20 percent or more of the vessel's gross register tonnage, deduct either 32 percent of the vessel's gross register tonnage or 1.75 times the total propelling machinery space, whichever the vessel owner elects.

(3) *Vessels Propelled by Paddle Wheel* For vessels propelled in whole or in part by paddle-wheel -

- (i) If the total propelling machinery space is 20 percent or less of the vessel's gross register tonnage, deduct $37/20$ times the total propelling machinery space;
- (ii) If the total propelling machinery space is more than 20 but less than 30 percent of the vessel's gross register tonnage, deduct 37 percent of the vessel's gross register tonnage; or
- (iii) If the total propelling machinery space is 30 percent or more of the vessel's gross register tonnage, deduct either 37 percent of the vessel's gross register tonnage or 1.5 times the total propelling machinery space, whichever the vessel owner elects.

§ 69.123 FIGURES

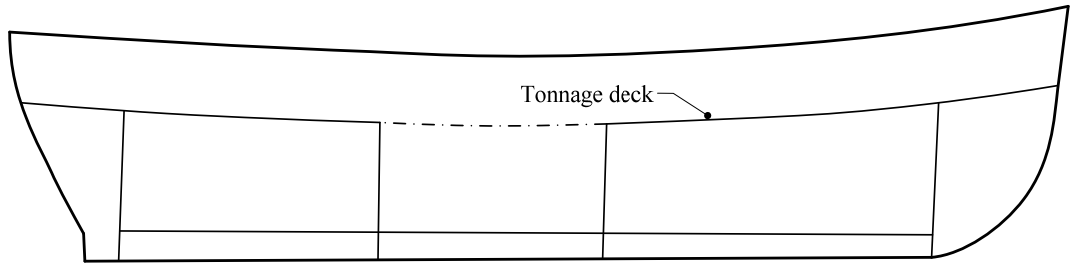

Figure 1

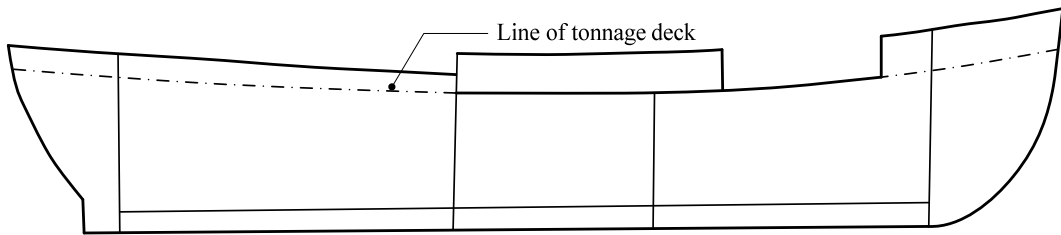

Figure 2

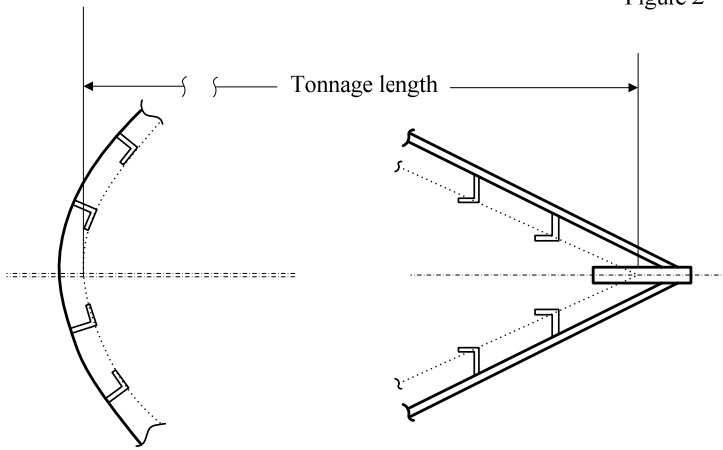

Figure 3

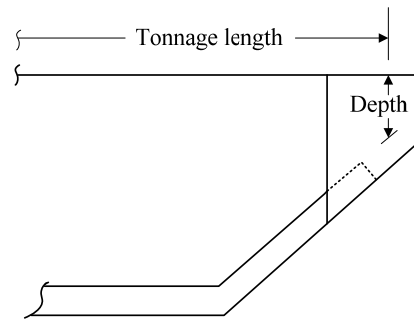

Figure 4

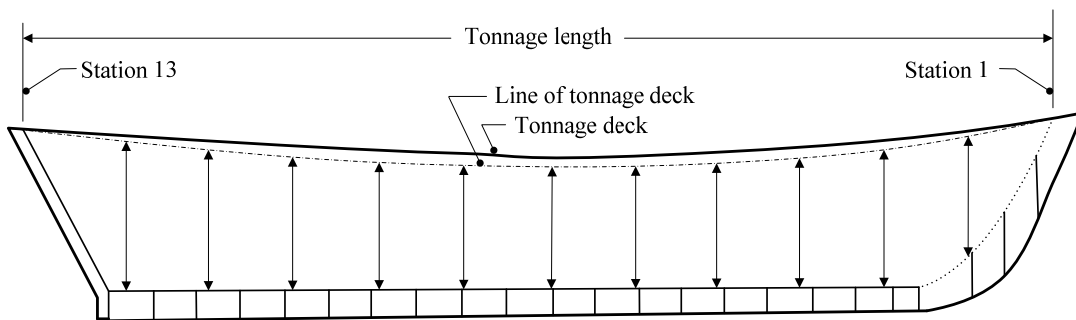

Figure 5

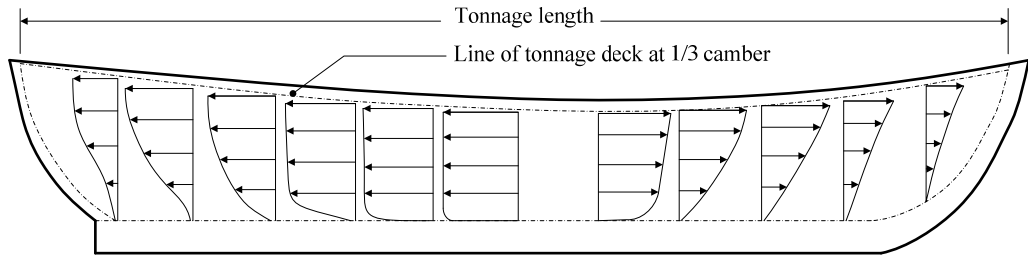

Figure 6

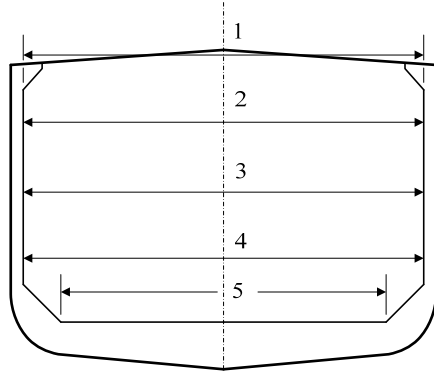

Figure 7

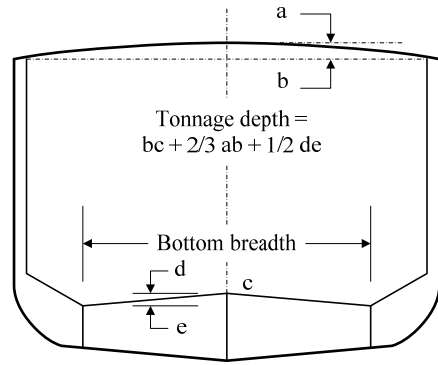

Figure 8

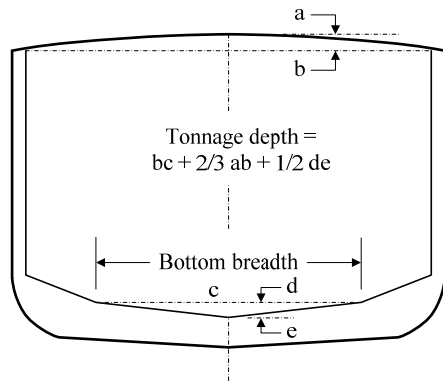

Figure 9

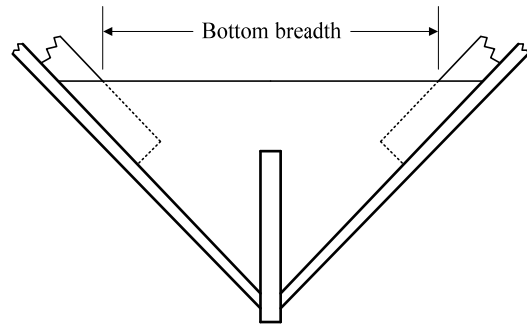

Figure 10

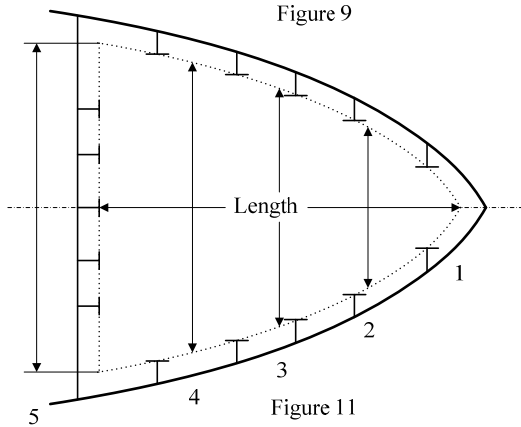

Figure 11

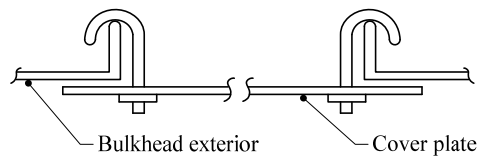

Figure 12

H = Height of main space.
H' = Height between crown and upper deck.
L/A = Light or air space above the upper deck.

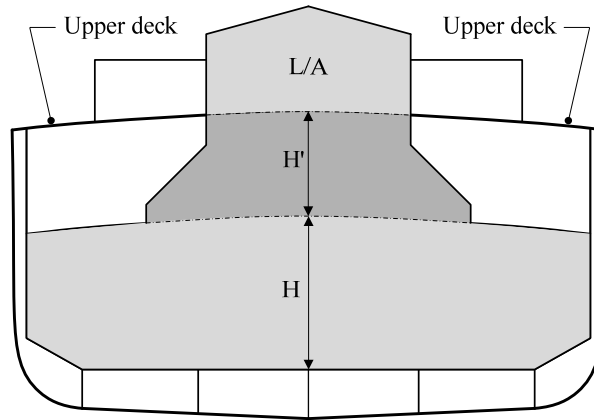

Figure 13

H = Height of main space.
H' = Height between crown and upper deck.
L/A = Light or air space above the upper deck.

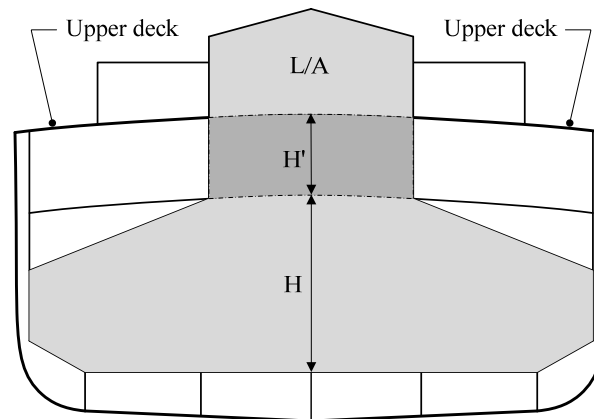

Figure 14

(Page intentionally left blank)

DUAL REGULATORY MEASUREMENT SYSTEM (46 CFR 69 Subpart D with Interpretations)

§ 69.151 PURPOSE

This subpart prescribes measurement requirements for the assignment of either one gross and one net register tonnage or two gross and two net register tonnages to vessels under this subpart.

§ 69.153 APPLICATION OF OTHER LAWS

(a) *Use of Higher Tonnage*

If a vessel is assigned two gross register tonnages under § 69.175(b), the higher gross register tonnage is the tonnage used when applying inspection, manning, and load line laws and regulations to the vessel.

(b) *Load Line Requirements*

Tonnage marks are not to be construed as additional load line marks. Whether or not a tonnage mark is submerged under § 69.171 has no effect on the applicability of load line laws and regulations.

§ 69.155 MEASUREMENT REQUIREMENTS

Except as otherwise required by this subpart, the measurement requirements under the Standard Regulatory Measurement System in subpart C of this part apply to the measurement of vessels this part.

§ 69.157 DEFINITIONS

Terms used in this subpart that are defined in § 69.103 have the same meaning as in § 69.103, except the terms listed below. As used in this subpart -

GROSS REGISTER TONNAGE is defined in § 69.161(a).

LINE FOR FRESH AND TROPICAL WATERS means the line described in § 69.177(b)(2).

LINE OF THE SECOND DECK means the line described in § 69.181.

LINE OF THE UPPERMOST COMPLETE DECK means a longitudinal line at the underside of the uppermost complete deck or, if that deck is stepped, the longitudinal line of the underside of the lowest portion of that deck parallel with the upper portions of that deck.

NET REGISTER TONNAGE is defined in § 69.161(b).

SECOND DECK means the next deck below the uppermost complete deck that meets the following:

- (a) Is continuous athwartships and in a fore-and-aft direction at least between peak bulkheads, even though the deck may have interruptions or openings due to propelling machinery spaces, to hatch and ventilation trunks not extending longitudinally completely between main transverse bulkheads, to ladder and stairway openings, to chain lockers, or to cofferdams.
- (b) Is fitted as an integral and permanent part of the vessel.
- (c) Has proper covers to all main hatchways.
- (d) Does not have steps the total of which exceed 48 inches in height.

TONNAGE DECK means, for a vessel with only one deck, the uppermost complete deck and, for a vessel with a second deck, the second deck.

TONNAGE MARK means the line described in § 69.177(a)(2).

§ 69.159 APPLICATION FOR MEASUREMENT SERVICES

Applications for measurement services under this subpart must include the application information and plans required under § 69.105. The application must indicate whether a line for fresh and tropical waters is requested under § 69.177(b) and, for vessels with more than one deck, indicate whether one or two sets of tonnages are desired under § 69.175.

§ 69.161 GROSS AND NET REGISTER TONNAGES

- (a) **GROSS REGISTER TONNAGE** means the tonnage of a vessel, less certain spaces exempt under § 69.169, and is the sum of the following:
- (1) Under-deck tonnage (§ 69.163)
 - (2) Between-deck tonnage (§ 69.165)
 - (3) Superstructure tonnage (§ 69.167)
 - (4) Excess hatchway tonnage (§ 69.115)
 - (5) Tonnage of framed-in propelling machinery spaces included in calculating gross register tonnage (§ 69.121(d)(1)).
- (b) **NET REGISTER TONNAGE** means gross tonnage less deductions under § 69.119 and § 69.121.
- (c) The authorized measurement organization must issue a U.S. Tonnage Certificate as evidence of a vessel's measurement under this subpart, which must also indicate the vessel's measurement under the Convention Measurement System in subpart B of this part, if applicable. There is no requirement to maintain the U.S. Tonnage Certificate on board the vessel.

§ 69.163 UNDER-DECK TONNAGE

The under-deck tonnage provisions in § 69.109 apply; except that, under this subpart, spaces between the line of the tonnage deck and the tonnage deck itself due to a stepped tonnage deck are included in under-deck tonnage.

§ 69.165 BETWEEN-DECK TONNAGE

The between-deck tonnage provisions in § 69.111 apply, except that, under this subpart, between-deck space extends from the tonnage deck to the uppermost complete deck, rather than from the line of the tonnage deck to the line of the uppermost complete deck.

§ 69.167 SUPERSTRUCTURE TONNAGE

The superstructure tonnage provisions in § 69.113 apply; except that, under this part, spaces between the line of the uppermost complete deck and the uppermost complete deck itself due to a stepped uppermost complete deck are not included in the superstructure tonnage.

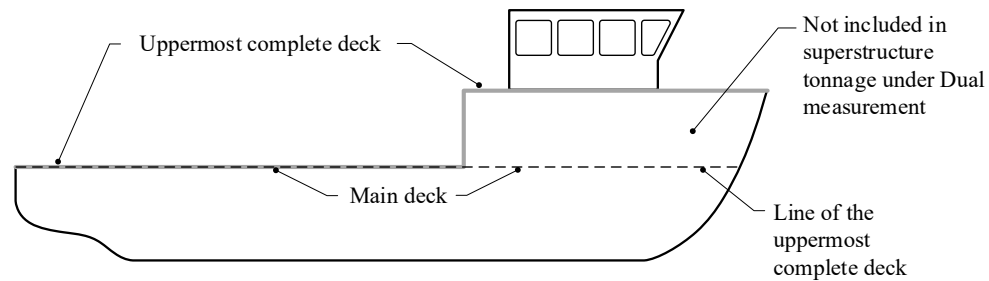

§ 69.169 SPACES EXEMPT FROM INCLUSION IN TONNAGE

The tonnage of the following spaces is exempt from inclusion in tonnage:

(a) **Miscellaneous Exemptible Superstructure Spaces**

Spaces listed in § 69.117(b) when located within the superstructure.

(b) **Passenger Spaces**

Spaces listed in § 69.117(c)(1) through (c)(3) when located above, but not on, the uppermost complete deck.

(c) **Water Ballast Spaces**

Spaces listed in § 69.117(f), regardless of location.

(d) **Dry Cargo and Stores Spaces**

Spaces available for carrying dry cargo and stores when located on or above the uppermost complete deck. *Any space is considered available for carrying dry cargo and stores if that space is not: 1) occupied by liquids (e.g., a fuel oil tank); or 2) used for the accommodation or berthing of passengers or crew (e.g., staterooms, lounges, dining areas and any passageways that serve such spaces).*

(e) **Additional Exemptions for Low Tonnage**

When a vessel is assigned a tonnage mark and the tonnage mark is not submerged,—

(1) **Miscellaneous Exemptible Spaces** Spaces listed in § 69.117(b) when located between the uppermost complete deck and the second deck;

(2) **Passenger Spaces on the Uppermost Complete Deck** Spaces listed in § 69.117(c)(1) through (c)(3) when located on the uppermost complete deck; and

(3) **Dry Cargo and Stores Spaces** Spaces available for carrying dry cargo and stores, *as described in § 69.169(d)*, when located between the uppermost complete deck and the second deck.

§ 69.171 WHEN THE TONNAGE MARK IS CONSIDERED SUBMERGED

For the purpose of this subpart, a tonnage mark is considered submerged when—

- (a) In salt or brackish water, the upper edge of the tonnage mark is submerged; and
- (b) In fresh or tropical water, the upper edge of the line for fresh and tropical waters is submerged.

§ 69.173 TONNAGE ASSIGNMENTS FOR VESSELS WITH ONLY ONE DECK

A vessel without a second deck is assigned only one gross and one net register tonnage. In calculating the gross register tonnage, only the exemptions in § 69.169 (a) through (d) are allowed. Markings under § 69.177 are not permitted on these vessels.

§ 69.175 TONNAGE ASSIGNMENTS FOR VESSELS WITH A SECOND DECK

(a) General

At the option of the vessel owner, a vessel having a second deck is assigned either: 1) two gross and two net register tonnages; or 2) one gross and one net register tonnage corresponding to the lower gross and net register tonnages.

(b) High / Low Tonnages Assigned

If two gross and two net register tonnages are assigned, the higher tonnages (i.e., those based only on exemptions under § 69.169 (a) through (d)) are applicable when the upper edge of the tonnage mark is submerged and the lower tonnages (i.e. those based only on all exemptions under § 69.169) are applicable when the upper edge of the tonnage mark is not submerged.

(c) Only Low Tonnages Assigned

If only the low gross and low net register tonnages, as calculated under paragraph (b) of this section, are assigned, these tonnages are applicable at all times. On these vessels, a load line must be assigned at a level below the line of the second deck, and the tonnage mark must be located in accordance with § 69.177(a)(6) at the level of the uppermost part of the load line grid.

§ 69.177 MARKINGS

The following table provides an overview of the marking requirements of this section:

GENERAL TONNAGE MARKING REQUIREMENTS		
<u>Two Deck Vessel</u>	<u>Load Line Assigned</u>	<u>Load Line Not Assigned</u>
HIGH AND LOW TONNAGES	Must have tonnage mark with triangle	Must have tonnage mark with triangle, and freeboard deck mark
LOW TONNAGES ONLY	Must have tonnage mark with triangle	Ineligible for measurement under Dual Measurement System
<u>One Deck Vessel</u>	No tonnage markings on hull	No tonnage markings on hull

(a) Tonnage Mark

- (1) **General** All vessels with a second deck that are measured under this subpart must have, on each side of the vessel, a tonnage mark, and an inverted triangle identifying the tonnage mark, as described and located under this section. (See the figure in § 69.183(a).) Vessels with only one deck are not assigned markings under this section.
- (2) **Tonnage Mark Characteristics** The tonnage mark is a horizontal line 15 inches long and one inch wide. The tonnage mark must be designated by a welded bead or other permanent mark 15 inches long placed along the top edge of the tonnage mark.
- (3) **Inverted Triangle Characteristics** Above the tonnage mark is placed an inverted equilateral triangle, each side of which is 12 inches long and one inch wide, with its apex touching the upper edge of the center of the tonnage mark.
- (4) **Longitudinal Placement** If the vessel has a load line mark, the longitudinal location of the center of the tonnage mark must be between 21 inches and six feet six inches aft of the vertical centerline of the load line ring. (See the figures in § 69.183 (b) and (c).) If the vessel does not have a load line mark, the center of the tonnage mark must be located amidships.

(5) **Vertical Placement (High / Low Tonnages Assigned)** Except as under paragraph (a)(6) of this section, the upper edge of the tonnage mark must be located below the line of the second deck at the distance indicated in Table 69.177(a)(5). (See the figure in § 69.183(b).)

TABLE 69.177(a)(5)—MINIMUM DISTANCE IN INCHES BETWEEN THE TONNAGE MARK AND THE LINE OF THE SECOND DECK

L (in feet)	L divided by D									
	12	13	14	15	16	17	18	19	20	
220 and under	2.0	2.0	2.0	2.0	2.0	2.0	2.0	2.0	2.0	2.0
230	3.2	2.0	2.0	2.0	2.0	2.0	2.0	2.0	2.0	2.0
240	4.7	2.0	2.0	2.0	2.0	2.0	2.0	2.0	2.0	2.0
250	6.3	3.3	2.0	2.0	2.0	2.0	2.0	2.0	2.0	2.0
260	8.0	4.8	2.1	2.0	2.0	2.0	2.0	2.0	2.0	2.0
270	9.9	6.4	3.5	2.0	2.0	2.0	2.0	2.0	2.0	2.0
280	11.8	8.1	4.9	2.1	2.0	2.0	2.0	2.0	2.0	2.0
290	13.9	9.9	6.5	3.5	2.0	2.0	2.0	2.0	2.0	2.0
300	16.0	11.7	8.1	4.9	2.1	2.0	2.0	2.0	2.0	2.0
310	18.3	13.7	9.8	6.4	3.5	2.0	2.0	2.0	2.0	2.0
320	20.7	15.8	11.7	8.1	4.9	2.1	2.0	2.0	2.0	2.0
330	23.2	18.0	13.6	9.8	6.4	3.5	2.0	2.0	2.0	2.0
340	25.9	20.4	15.7	11.6	8.1	4.9	2.1	2.0	2.0	2.0
350	28.7	22.9	17.9	13.6	9.8	6.5	3.6	2.0	2.0	2.0
360	31.7	25.5	20.2	15.7	11.7	8.2	5.0	2.2	2.0	2.0
370	34.7	28.3	22.7	17.9	13.6	9.9	6.6	3.7	2.0	2.0
380	38.0	31.1	25.3	20.2	15.7	11.8	8.3	5.2	2.4	2.4
390	41.3	34.1	27.9	22.6	17.9	13.8	10.1	6.8	3.8	3.8
400	44.8	37.2	30.7	25.0	20.1	15.8	11.9	8.4	5.3	5.3
410	48.2	40.3	33.5	27.7	22.6	18.1	14.0	10.4	7.2	7.2
420	51.5	43.4	36.4	30.4	25.2	20.6	16.4	12.7	9.7	9.7
430	54.8	46.5	39.4	33.3	27.9	23.2	19.0	15.2	11.8	11.8
440	58.4	49.9	42.6	36.4	30.9	26.0	21.7	17.8	14.4	14.4
450	62.1	53.4	46.0	39.6	33.9	29.0	24.6	20.6	17.1	17.1
460	65.9	57.0	49.5	42.9	37.1	32.1	27.6	23.5	19.9	19.9
470	69.8	60.7	53.0	46.3	40.4	35.2	30.6	26.5	22.8	22.8
480	73.7	64.4	56.5	49.7	43.7	38.4	33.7	29.5	25.7	25.7
490	77.5	68.1	60.0	53.0	46.9	41.5	36.7	32.4	28.5	28.5
500	81.2	71.6	63.4	56.2	50.0	44.5	39.6	35.2	31.2	31.2
510	84.9	75.1	66.7	59.4	53.0	47.4	42.4	37.9	33.9	33.9
520	88.4	78.4	69.9	62.4	55.9	50.2	45.1	40.5	36.4	36.4
530	91.8	81.6	72.9	65.3	58.7	52.9	47.7	43.0	38.8	38.8
540	95.2	84.8	75.9	68.1	61.4	55.5	50.2	45.4	41.2	41.2
550	98.4	87.8	78.8	70.9	64.0	58.0	52.6	47.8	43.4	43.4
560	101.6	90.8	81.6	73.6	66.6	60.5	55.0	50.1	45.6	45.6
570	104.8	93.8	84.4	76.3	69.2	62.9	57.3	52.3	47.8	47.8
580	107.9	96.8	87.2	78.9	71.7	65.3	59.6	54.5	49.9	49.9
590	111.0	99.7	90.0	81.5	74.2	67.7	61.9	56.7	52.0	52.0
600	114.0	102.5	92.6	84.0	76.5	69.9	64.0	58.8	54.0	54.0
610	117.0	105.3	95.2	86.5	78.9	72.1	66.2	60.8	56.0	56.0
620	120.0	108.0	97.8	88.9	81.2	74.4	68.3	62.8	58.0	58.0
630	122.9	110.7	100.4	91.3	83.5	76.6	70.4	64.8	59.9	59.9
640	125.7	113.4	102.9	93.7	85.8	78.7	72.4	66.8	61.7	61.7
650	128.6	116.1	105.4	96.1	88.0	80.8	74.4	68.7	63.6	63.6
660	131.4	118.7	107.8	98.3	90.1	82.8	76.3	70.6	65.3	65.3
670	134.2	121.2	110.2	100.6	92.2	84.8	78.3	72.4	67.1	67.1
680	136.9	123.8	112.8	102.9	94.3	86.8	80.2	74.2	68.9	68.9
690	139.6	126.3	115.0	105.1	96.4	88.8	82.1	76.0	70.6	70.6
700	142.3	128.8	117.3	107.3	98.5	90.8	83.9	77.8	72.3	72.3
710	144.9	131.3	119.6	109.4	100.5	92.7	85.7	79.5	73.9	73.9
720	147.5	133.7	121.8	111.5	102.5	94.6	87.5	81.2	75.5	75.5
730	150.1	136.1	124.0	113.6	104.5	96.5	89.3	82.9	77.1	77.1
740	152.7	138.5	126.2	115.7	106.5	98.3	91.5	84.5	78.7	78.7
750	155.3	140.8	128.5	117.8	108.4	100.1	92.8	86.1	80.3	80.3
760	157.8	143.1	130.6	119.7	110.3	101.9	94.4	87.8	81.7	81.7
770	160.2	145.4	132.7	121.7	112.1	103.6	96.0	89.3	83.2	83.2
780	162.6	147.6	134.8	123.7	113.9	105.3	97.6	90.8	84.7	84.7
790	165.1	149.9	136.9	125.6	115.7	107.0	99.2	92.3	86.1	86.1
800	167.5	152.1	138.9	127.4	117.4	108.6	100.8	93.8	87.4	87.4

L = the length in feet of the line of the second deck at the centerline of the vessel from the inner surface of the frames at the vessel's stem to the inner surface of the frames at the vessel's stern.

D = The vertical distance in feet from the top of the flat keel of the vessel to the line of the second deck.

EXAMPLE (1) For a vessel in which L = 450 feet and L/D = 15 feet, read down from the L/D column "15" and to the right on the column "450" to where the two columns intersect at 39.6. The tonnage mark must be located 39.6 inches below the line of the second deck.

EXAMPLE (2) If L or L/D is an intermediate number, the distance "a" between the tonnage mark and the line of the second deck must be obtained by linear interpolation. For a vessel in which L = 424.80 feet and L/D = 15.17:

L	Table L/D = 15	Actual L/D = 15.17	Table L/D = 16
Table 420	30.4	25.2
Actual 424.80	r	a	s
Table 430	33.3	27.9

Interpolation:

$$r=30.4+0.48(33.3-30.4)=31.79$$

$$s=25.2+0.48(27.9-25.2)=26.50$$

$$a=r-0.17(r-s)=31.79-0.17(31.79-26.50)=30.89 \text{ inches}$$

(6) **Vertical Placement (Low Tonnage Assigned With Load Line)** For the following vessels, *which meet the criteria of both subsections (i) and (ii) below and* with a load line mark, the upper edge of the tonnage mark must be located at the level of the uppermost part of the load line grid.

- (i) Vessels assigned only one gross and one net register tonnage under § 69.175(c);
- (ii) Vessels for which a load line assigning authority certifies that the vessel's load line mark was located as though the second deck were the freeboard deck. *In other words, even if the second deck is not the freeboard deck for load line purposes, the load line must be assigned as if the second deck were the freeboard deck in order for the vessel to be assigned single low tonnages under the Dual Measurement System.*

(b) Line For Fresh and Tropical Waters

- (1) **General** Except as under paragraph (b)(4) of this section, a horizontal line for fresh and tropical waters may be assigned at the vessel owner's request.
- (2) **Characteristics of Fresh and Tropical Waters Line** The line must be nine inches long and one inch wide and located above and to the left of the tonnage mark at a distance equal to one forty-eighth of the distance from the top of the flat keel to the tonnage mark. The tonnage mark and the line for fresh and tropical waters must be connected by a vertical line one inch wide. (See the figure in § 69.183(a).)
- (3) **Permanent Marking Requirements** The line for fresh and tropical waters must be designated by a welded bead or other permanent mark nine inches long placed along the upper edge of the line.
- (4) **Restrictions When Only Low Tonnage is Assigned** For vessels with a load line mark, if the load line assigning authority certifies that the load line mark was located as though the second deck were the freeboard deck, a line for fresh and tropical waters must not be placed on the vessel.

(c) Freeboard Deck Mark

A vessel assigned two gross and two net register tonnages which has more than one deck and no load line mark assigned must have a mark on each side of the vessel with the same dimensions and location as the freeboard deck line mark under § 42.13–20 of this chapter, except that the mark must be located directly above the tonnage mark.

(d) The Line of the Second Deck

The line of the second deck must not be marked on the side of the vessel, except in the case of a freeboard deck line mark placed at the location of the second deck if the second deck is the actual freeboard deck for purposes of a vessel's load line assignment. *This prohibition shall not be construed to prohibit the assignment of a freeboard deck line mark under load line requirements at the location of the second deck if the second deck is the actual freeboard deck for purposes of load line assignment.*

(e) Color of Markings

All markings under this section must be maintained in either a light color on a dark background or a dark color on a light background.

§ 69.179 CERTIFICATION OF MARKINGS

(a) Measurement Organization Certification

Before a certificate of measurement is issued for a vessel requiring a tonnage mark, a certification by a measurement organization under § 69.15 that all markings meet the requirements of this subpart is

required. *As a minimum, this certification should consist of a signed written statement attesting to the following:*

- (1) **Tonnage Mark and Triangle** *The tonnage mark and associated inverted triangle are properly installed on both sides of the vessel, with the tonnage mark below the line of the second deck.*
- (2) **Freeboard Deck Mark** *For vessels without a load line assigned, the freeboard deck mark is properly installed on both sides of the vessel.*

(b) Coast Guard Verification

The Coast Guard, at any time, may verify markings under this subpart.

§ 69.181 LOCATING THE LINE OF THE SECOND DECK

(a) Second Deck Not Stepped

If the second deck is not stepped, the line of the second deck is the longitudinal line of the underside of the second deck at the side of the hull.

(b) Second Deck Stepped

If the second deck is stepped (as in the examples following this paragraph), the line of the second deck is a longitudinal line extended parallel to each portion of the second deck and located at the height of the underside of the amidships portion of the second deck at the side of the hull—

- (1) Plus, for each stepped portion of the second deck higher than the second deck at amidships, a distance equal to the length of the stepped portion divided by the total length of the second deck times the height that the step is above the height of the amidship portion of the second deck; and
- (2) Minus, for each stepped portion of the second deck lower than the second deck at amidships, a distance equal to the length of the stepped portion divided by the total length of the second deck times the height that the amidship portion of the second deck is above the height of the step.

Example: (1)

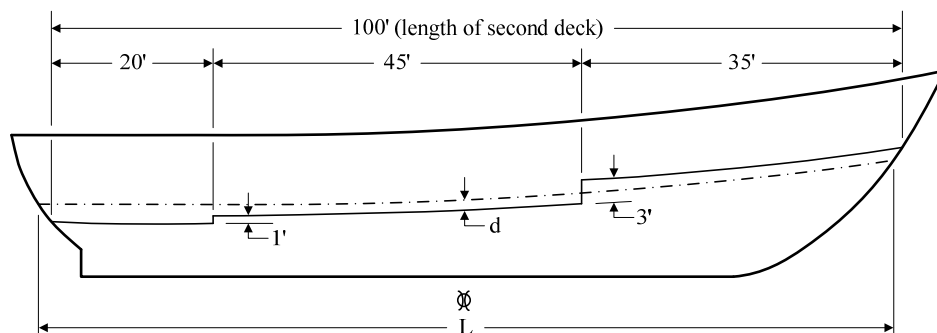

L = Length of the line of the second deck.

d = Distance from amidship portion of second deck to line of second deck.

$$d = \frac{35 \times 3}{100} - \frac{20 \times 1}{100} = +0.85 \text{ feet.}$$

Example: (2)

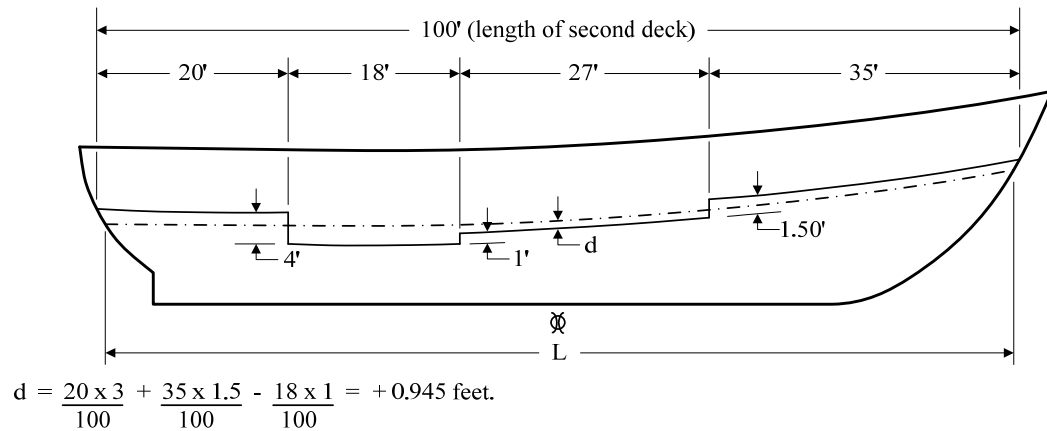

§ 69.183 FIGURES

(a) Tonnage Mark Triangle

Tonnage mark with an equilateral triangle and a line for fresh and tropical waters.

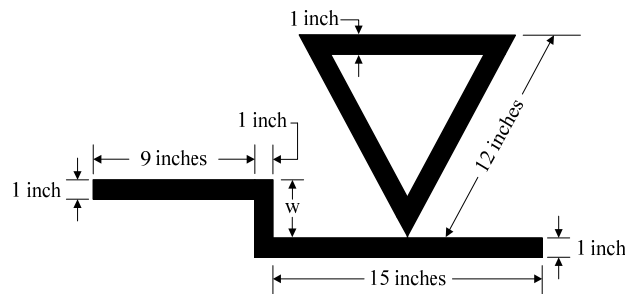

$W = 1/4a$ of the distance from the top of the flat keel to the tonnage mark. (See § 69.177(b)(2).)

(b) Tonnage Mark Location (*High and Low Tonnes*)

Tonnage mark location if the load line mark is not placed as though the second deck were the freeboard deck for load line purposes, but rather is placed on the basis that the uppermost complete deck is the freeboard deck.

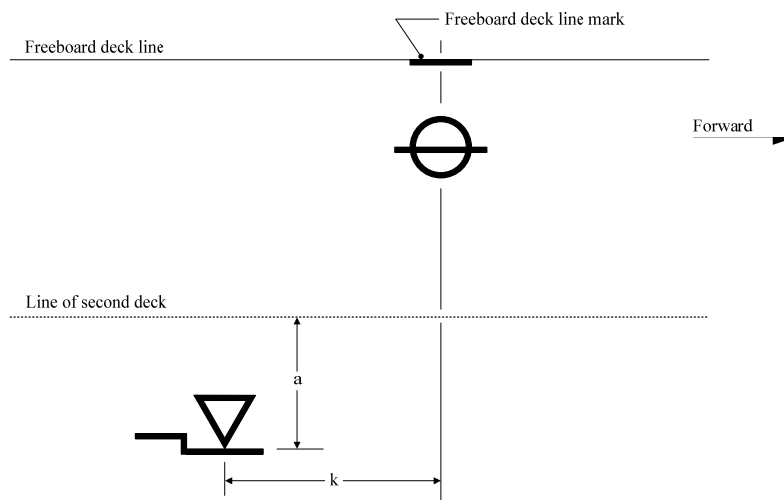

k = a distance between 21 inches and six feet six inches.
 a = distance derived from Table 69.177(a)(5).

(c) Tonnage Mark Location (*Low Tonnages Only*)

Tonnage mark location if the load line mark is placed as though the second deck were the freeboard deck. *In other words, although the second deck does not qualify as the freeboard deck for load line purposes, the load line mark is located by the load line assigning authority as if the second deck qualifies as the freeboard deck. In this figure, the freeboard deck for load line purposes is the uppermost complete deck, and the freeboard deck line mark is correctly shown at the level of the uppermost complete deck.*

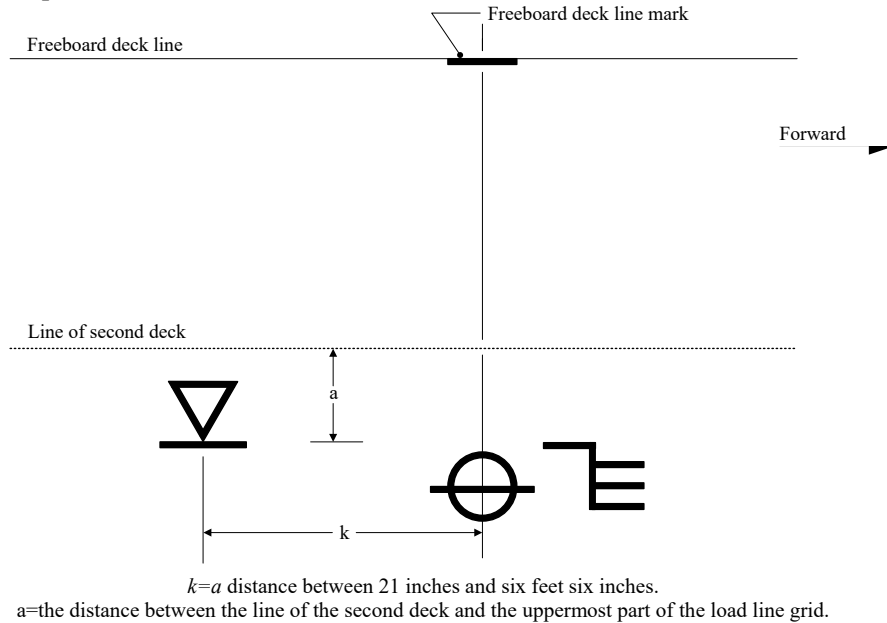

SIMPLIFIED REGULATORY MEASUREMENT SYSTEM (46 CFR 69 Subpart E with Interpretations)

§ 69.201 PURPOSE

This subpart prescribes the procedures for measuring a vessel under the Simplified Regulatory Measurement System described in 46 U.S.C. chapter 145, subchapter III.

§ 69.203 DEFINITIONS

As used in this subpart, and in Coast Guard Form CG-5397 under § 69.205 –

MULTI-HULL VESSEL means a vessel with more than one distinct hull. To be considered a distinct hull, the hull must connect to another hull only with structure that is not a part of the vessel's buoyant hull envelope.

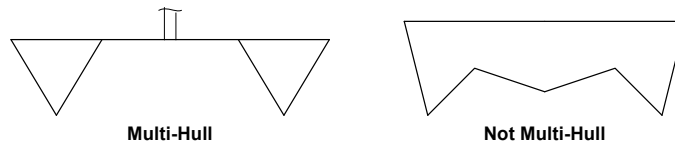

OVERALL BREADTH (B) means the horizontal distance taken at the widest part of the hull, excluding rub rails, from the outboard side of the skin (outside planking or plating) on one side of the hull to the outboard side of the skin on the other side of the hull.

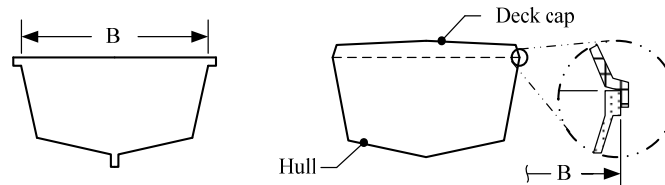

OVERALL DEPTH (D) means the vertical distance taken at or near midships from a line drawn horizontally through the uppermost edges of the skin (outside planking or plating) at the sides of the hull (excluding the cap rail, trunks, cabins, and deckhouses) to the outboard face of the bottom skin of the hull, excluding the keel. *Depth is measured at amidships for all cases except those in which there is a longitudinal discontinuity in the deck that occurs within 5% of the overall length on either side of amidships. In such cases, the greater depth is used.* For a vessel that is designed for sailing and has a keel faired to the hull, the keel is included in the "overall depth" if the distance to the bottom skin of the hull cannot be determined reasonably. (See § 69.201(a)(5).)

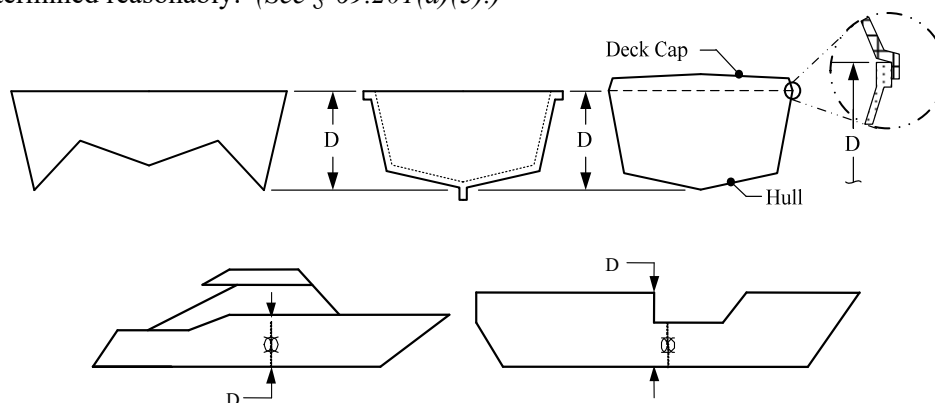

OVERALL LENGTH (L) means the horizontal distance between the outboard side of the foremost part of the stem and the outboard side of the aftermost part of the stern, excluding rudders, outboard motor brackets, and other similar fittings and attachments. *The following additional requirements apply:*

- (a) *Buoyant hull structures both fixed and removable are included in the overall length, and consequently in tonnage. Portions of watertight bulwarks and similar structures that function as a continuation of*

the vessel's hull and extend for a length of 10% or more of the overall length (with the structure included) are considered to be part of the buoyant hull envelope, provided there are no hull openings (such as an anchor hawsepipe) that could cause the associated space to flood. Refer to § 69.53 for the definition of watertight.

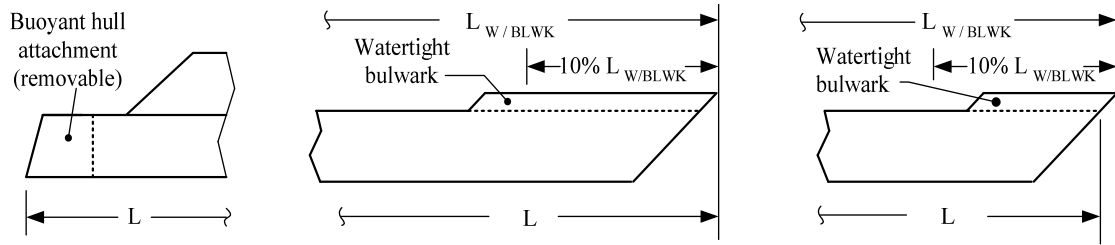

(b) Attachments that are typically not part of the buoyant hull envelope, and are therefore not included in the overall length, include bowsprits, overhanging decks, swim platforms, stern-wheel supports and non-watertight bulwarks.

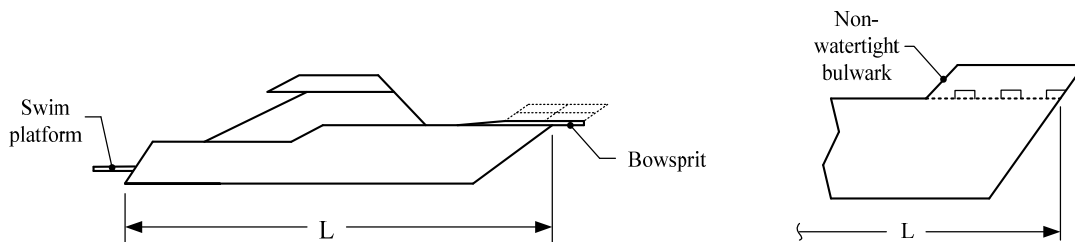

AMIDSHIPS or **MIDSHIPS** means the midpoint of the overall length. **NOTE:** The term “overall” as used above for breadth, depth and length differs from the naval architectural term of art for which all extended fittings of the hull are included.

REGISTERED BREADTH means –

- (a) For a single-hull vessel, the vessel’s overall breadth; and
- (b) For a multi-hull vessel, the horizontal distance taken at the widest part of the complete vessel between the outboard side of the skin (outside planking or plating) on the outboardmost side of one of the outboardmost hulls (e.g., port hull) to the outboard side of the skin on the outboardmost side of the other outboardmost hull (e.g., starboard hull), excluding rubrails.

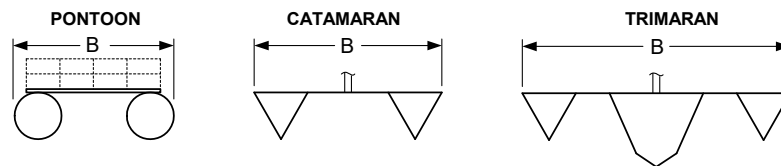

REGISTERED DEPTH means –

- (a) For a single-hull vessel, the vessel’s overall depth; and
- (b) For a multi-hull vessel, the overall depth of the deepest hull.

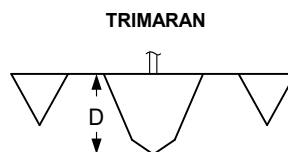

REGISTERED LENGTH means –

- (a) For a single-hull vessel, the vessel's overall length; and
- (b) For a multi-hull vessel, the horizontal distance between the outboard side of the foremost part of the stem of the foremost hull and the outboard side of the aftermost part of the stern of the aftermost hull, excluding fittings and attachments.

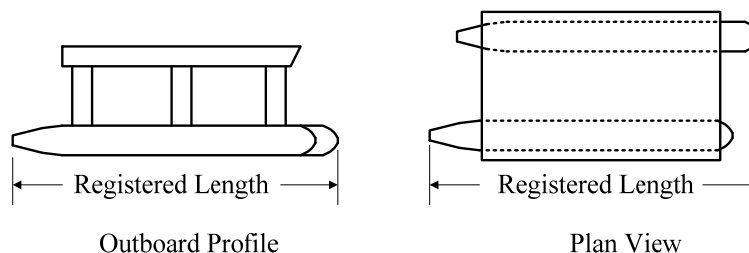

STEM means the foremost boundary of the buoyant hull envelope.

STERN means the aftermost boundary of the buoyant hull envelope.

VESSEL DESIGNED FOR SAILING means a vessel which has the fine lines of a sailing craft and is capable of being propelled by sail, whether or not the vessel is equipped with an auxiliary motor, a decorative sail, or a sail designed only to steady the vessel.

§ 69.205 APPLICATION FOR MEASUREMENT SERVICES

- (a) Except as noted under paragraph (c) of this section, to apply for measurement under this subpart, the vessel owner must complete an Application for Simplified Measurement (form CG-5397). If the vessel is documented, or intended to be documented, as a vessel of the United States under part 67 of this chapter, the vessel owner must submit the application form to the National Vessel Documentation Center. Otherwise, the form is not further processed, but may be retained, at the vessel owner's option, as evidence of the tonnage measurement under this part.
- (b) The Application for Simplified Measurement (form CG-5397) must include the following information:
 - (1) Vessel's name and number (e.g., official number, International Maritime Organization (IMO) number, or Coast Guard number).
 - (2) Vessel hull identification number or other number assigned by builder.
 - (3) Hull material.
 - (4) Hull shape.
 - (5) Overall length, breadth, and depth of vessel and each of the vessel's individual hulls.
 - (6) Location of any propelling machinery (e.g., inside or outside of the hull).
 - (7) Dimensions of the principal deck structure, if its volume exceeds the volume of the hull.
- (c) At the vessel owner's option, a Builder's Certification and First Transfer of Title (form CG-1261), which includes the same information specified in paragraph (b) of this section may be submitted to the National Vessel Documentation Center instead of the Application for Simplified Measurement for a vessel that is documented, or intended to be documented, as a vessel of the United States under part 67 of this chapter.

§ 69.207 MEASUREMENTS

- (a) All lengths and depths must be measured in a vertical plane at centerline and breadths must be measured in a line at right angles to that plane. All dimensions must be expressed in feet and inches to the nearest inch or in feet and tenths of a foot to the nearest tenth of a foot. *Length is measured in a vertical (longitudinal) plane at the centerline of the hull(s). Breadth is measured in a vertical (transverse) plane at right angles to the centerline at the widest part of the hull. Depth is measured in a vertical (transverse) plane at right angles to the centerline at or near amidships*
- (b) For a multi-hull vessel, each hull must be measured separately for overall length, breadth, and depth and the vessel as a whole must be measured for registered length, breadth, and depth.
- (c) The Coast Guard may verify dimensions of vessels measured under this subpart.

§ 69.209 GROSS AND NET REGISTER TONNAGES

(a) Gross Register Tonnage

- (1) Except as in paragraph (a)(2) through (a)(5) of this section, the gross register tonnage of a vessel designed for sailing is one-half of the product of its overall length, overall breadth, and overall depth (LBD) divided by one hundred (i.e., 0.50 LBD/100), and the gross register tonnage of a vessel not designed for sailing is 0.67 LBD/100.

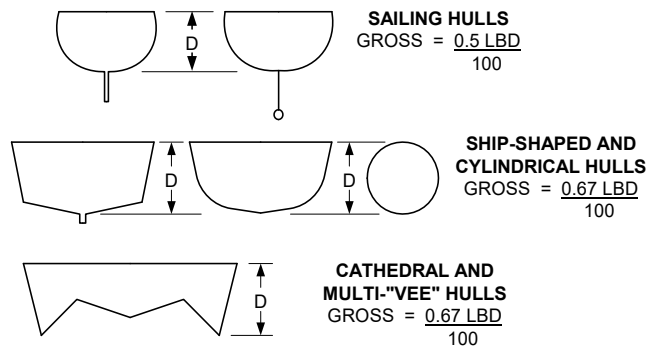

- (2) The gross register tonnage of a vessel with a hull that approximates in shape a rectangular geometric solid (barge-shape) is 0.84 LBD/100.



- (3) The gross register tonnage of a multi-hull vessel is the sum of all the hulls as calculated under this section.

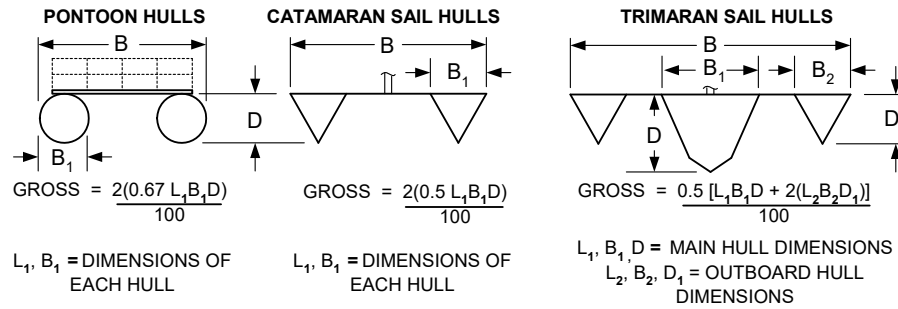

- (4) If the volume of the principal deck structure of a vessel is as large as, or larger than, the volume of the vessel's hull, the volume of the principal deck structure in tons of 100 cubic feet is added to the tonnage of the hull to establish the vessel's gross tonnage. The volume of the principal deck structure of a vessel is determined by the product of its average dimensions.

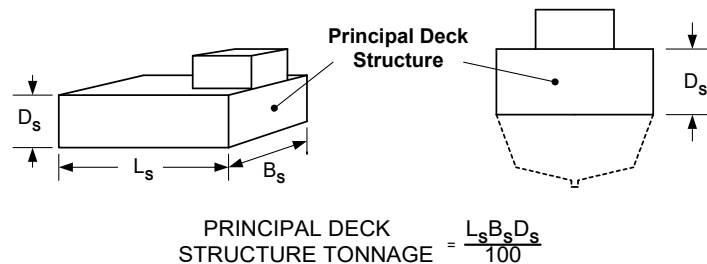

NOTE: A deck structure in this context is as defined in § 69.53, and which also qualifies as an enclosed space as defined in § 69.59. Deck structures that are comprised entirely of excluded spaces as defined in § 69.61 are ignored when calculating tonnage under the simplified measurement system. Conversely, deck structures that are comprised partially of excluded spaces are treated as if the entire structure is closed. Typically, the covered open structure on smaller pontoon boats is ignored from measurement, provided the sides are enclosed only by roll-down canvas or similar temporary awning-like arrangements.

- (5) If the overall depth of a vessel designed for sailing includes the keel, only 75 percent of that depth is used for gross tonnage calculations.



- (6) The gross tonnage of a drydock having wingwalls that are part of the buoyant hull envelope is calculated assuming the depth includes the height of the wingwalls and applying a shape coefficient of 0.84 as follows:

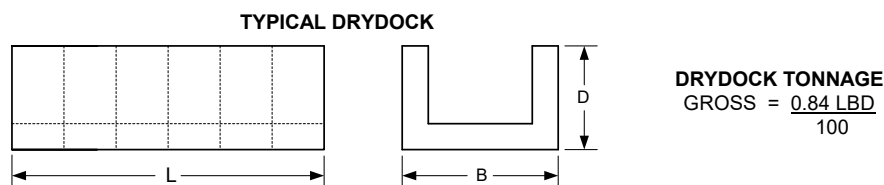

(b) Net Register Tonnage

(1) For a vessel having propelling machinery in its hull –

- (i)** The net register tonnage is 90 percent of its gross tonnage, if it is a vessel designed for sailing;
or

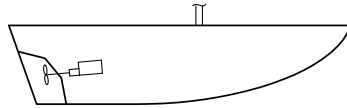

**SAILING HULLS
(PROPELLING MACHINERY IN
HULL)**
NET = 0.9 GROSS

- (ii)** The net register tonnage is 80 percent of its gross tonnage, if it is not designed for sailing.

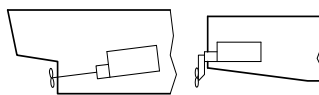

**SHIP-SHAPED, PONTOON AND
BARGE HULLS
(PROPELLING MACHINERY IN
HULL)**
NET = 0.8 GROSS

(2) For a vessel having no propelling machinery in its hull, the net register tonnage is the same as its gross tonnage.

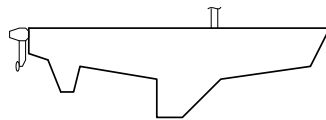

**SAILING HULLS
(NO PROPELLING MACHINERY IN
HULL)**
NET = GROSS

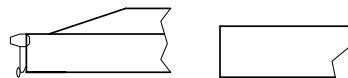

**SHIP-SHAPED, PONTOON AND
BARGE HULLS
(NO PROPELLING MACHINERY
IN HULL)**
NET = GROSS

(c) Certification of Measurement

For a vessel that is documented as a vessel of the United States under part 67 of this chapter, the vessel's Certificate of Documentation serves as evidence of measurement under this subpart. For all other vessels, a completed Application for Simplified Measurement (form CG-5397) serves as evidence of the tonnage measurement under this part.

§ 69.211 TREATMENT OF NOVEL TYPE VESSELS

Refer questions regarding the application of the tonnage measurement rules under this subpart to novel type vessels to the Commandant. *Examples of novel craft are Wing-in-Ground (WIG), SLICE and Small Waterplane Twin Hull (SWATH) craft.*

APPENDIX A

GRANDFATHERING PROVISIONS

§ A.1 PURPOSE

The purpose of this Appendix is to authorize specific circumstances under which interpretations of the tonnage regulations may be applied that predate the interpretations promulgated by changes to this MTN.

§ A.2 DISCUSSION

This MTN is intended to provide sufficient interpretive information to enable correct and consistent application of the tonnage measurement regulations. While the MSC's goal is to ensure the interpretative information is clear and keeps pace with evolution of vessel designs, the MSC recognizes that designers and measurement organizations may apply reasonable interpretations of the regulations that are subsequently superseded by changes to the MTN. In order to provide relief to owners who are having vessels designed or redesigned on the basis of interpretations that are subsequently superseded, the MSC considers that grandfathering consistent with the provisions of § 69.13(c) of the tonnage regulations, as amended, for applying tonnage measurement rules that predate amended rules should be extended to such vessels.

§ A.3 GRANDFATHERING AUTHORIZATION

Interpretations of the tonnage regulations that immediately predate the interpretations promulgated by a change to this MTN may be applied at the option of the vessel's owner, for vessels in either of the following categories:

- (a) A vessel for which tonnages have not been certified and which was contracted for on or before the date of the MTN change.
- (b) A vessel for which tonnages have been certified, but which has undergone modifications that were contracted for on or before the date of the MTN change.

A vessel for which tonnages have already been certified should not be remeasured for the purpose of applying the latest interpretations of this MTN, except upon request by the vessel's owner and at the owner's expense.

§ A.4 CONSIDERATION OF OTHER VESSELS

The MSC recognizes that there may be unique circumstances under which grandfathering should be extended to vessels other than those described in §A.3 above. The MSC will give consideration to requests to extend grandfathering to other vessels. Such requests must be made in writing to the Commanding Officer, MSC, and must be accompanied by information detailing the specific stage of design and/or construction of the vessel on the date of the MTN change that promulgated the superseded interpretations.

(Page intentionally left blank)

APPENDIX B 1969 Tonnage Convention¹

INTERNATIONAL CONVENTION ON TONNAGE MEASUREMENT OF SHIPS, 1969

The Contracting Governments, DESIRING to establish uniform principles and rules with respect to the determination of tonnage of ships engaged on international voyages;

CONSIDERING that this end may best be achieved by the conclusion of a Convention;

HAVE AGREED as follows:

ARTICLE 1 GENERAL OBLIGATION UNDER THE CONVENTION

The Contracting Governments undertake to give effect to the provisions of the present Convention and the Annexes hereto which shall constitute an integral part of the present Convention. Every reference to the present Convention constitutes at the same time a reference to the Annexes.

ARTICLE 2 DEFINITIONS

For the purpose of the present Convention, unless expressly provided otherwise:

- (1) "Regulations" means the Regulations annexed to the present Convention;
- (2) "Administration" means the Government of the State whose flag the ship is flying;
- (3) "international voyage" means a sea voyage from a country to which the present Convention applies to a port outside such country, or conversely. For this purpose, every territory for the international relations of which a Contracting Government is responsible or for which the United Nations are the administering authority is regarded as a separate country;
- (4) "gross tonnage" means the measure of the overall size of a ship determined in accordance with the provisions of the present Convention;
- (5) "net tonnage" means the measure of the useful capacity of a ship determined in accordance with the provisions of the present Convention;
- (6) "new ship" means a ship the keel of which is laid, or which is at a similar stage of construction, on or after the date of coming into force of the present Convention;²
- (7) "existing ship" means a ship which is not a new ship;

¹ This Appendix is a reprint, in standard font, of the International Convention on Tonnage Measurement of Ships, 1969, with International Maritime Organization (IMO) Unified Interpretations of Circular TM.5/Circ.6 inserted in italics font, along with related figures. The terms "per cent", "connexion", "draught", "moulded", and "metre" have the same meaning as the terms "percent", "connection", "draft", "molded", and "meter". International Association of Classification Societies (IACS) and United States (U.S.) Coast Guard interpretations and related figures are also inserted following the associated text. The United States applies IMO and IACS interpretations, unless otherwise indicated.

² The United States applies IMO interpretations for the term "at a similar stage of construction" (e.g., the stage at which construction identifiable with a specific vessel began, and assembly of this vessel commenced comprising at least 50 metric tons or one percent of the estimated mass of all structural material, whichever is less.)

(8) "length" means 96 per cent of the total length on a waterline at 85 per cent of the least moulded depth measured from the top of the keel, or the length from the fore side of the stem to the axis of the rudder stock on that waterline, if that be greater. In ships designed with a rake of keel the waterline on which this length is measured shall be parallel to the designed waterline;

A.2(8)-1 *When a ship does not have a rudder stock, the length should be taken as 96% of the total length on a waterline at 85% of the least moulded depth measured as defined in Regulation 2(2).*

A.2(8)-2 *The 96% overall length should be used for ships that do not have a clearly defined stem or stern, such as column-stabilized units, submersibles, floating docks, and similar ships.*

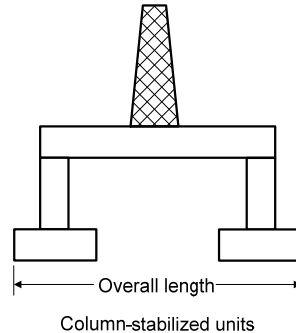

A.2(8)-3 *In the definition of "length" in Article 2(8), the term "least moulded depth" is the vertical distance measured from the top of the flat plate keel (or equivalent lower terminus as described in Regulation 2(2)) at the lowest point along the keel's length to the horizontal line that is tangent to the underside of the upper deck at the ship's side (or equivalent upper terminus as described in Regulation 2(2)) at the lowest point along the upper deck's length. For the purpose of this definition, the ship is considered to be trimmed on a waterline parallel to the design waterline.*

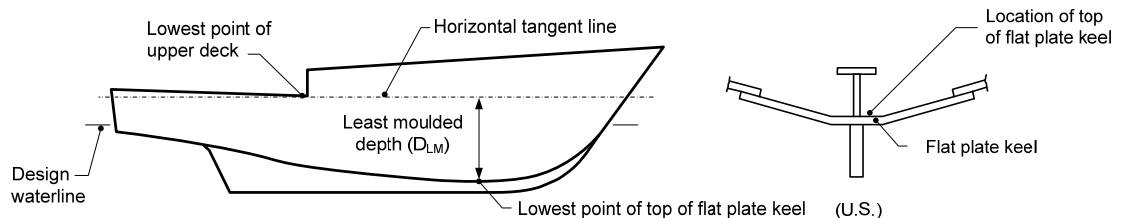

A.2(8)-4 *Where more than one rudder is fitted, the aftermost rudder stock is the rudder stock to be considered when determining the length.*

A.2(8)-U1 (U.S.) *The "total length" is the length of the hull from the fore side of the stem to the aftermost side of the stern, where the stem and stern define the foremost and aftermost boundaries, respectively, of the buoyant hull envelope.*

A.2(8)-U2 (U.S.) *The "flat plate keel" is the horizontal, centerline, bottom shell strake constituting the lower flange of the keel. The "top of the flat plate keel" refers to the top of this plate. In vessels that do not have a flat plate keel, the equivalent to the "top of the flat plate keel" is established as described in the definition for molded depth.*

(9) "Organization" means the Inter-Governmental Maritime Consultative Organization.³

³ In 1982, the name "Inter-Governmental Maritime Consultative Organization" (IMCO) was changed to "International Maritime Organization" (IMO).

ARTICLE 3 APPLICATION

- (1) The present Convention shall apply to the following ships engaged on international voyages:
- (a) ships registered in countries the Governments of which are Contracting Governments;
 - (b) ships registered in territories to which the present Convention is extended under Article 20; and
 - (c) unregistered ships flying the flag of a State, the Government of which is a Contracting Government.
- (2) The present Convention shall apply to:
- (a) new ships;
 - (b) existing ships which undergo alterations or modifications which the Administration deems to be a substantial variation in their existing gross tonnage;
 - (c) existing ships if the owner so requests; and
 - (d) all existing ships, twelve years after the date on which the Convention comes into force, except that such ships, apart from those mentioned in (b) and (c) of this paragraph, shall retain their then existing tonnages for the purpose of the application to them of relevant requirements under other existing International Conventions.⁴
- A.3(2)(d)-1 The term "alterations or modifications which the Administration deems to be a substantial variation in their existing tonnage" should be interpreted to mean "an increase or decrease of more than 1% in the gross tonnage calculated in accordance with the 1969 Tonnage Convention."*⁵
- (3) Existing ships to which the present Convention has been applied in accordance with sub-paragraph (2)(c) of this Article shall not subsequently have their tonnages determined in accordance with the requirements which the Administration applied to ships on international voyages prior to the coming into force of the present Convention.

ARTICLE 4 EXCEPTIONS

- (1) The present Convention shall not apply to:
- (a) ships of war; and
 - (b) ships of less than 24 metres (79 feet) in length.
- (2) Nothing herein shall apply to ships solely navigating:
- (a) the Great Lakes of North America and the River St. Lawrence as far east as a rhumb line drawn from Cap des Rosiers to West Point, Anticosti Island, and, on the north side of Anticosti Island, the meridian of longitude 63° W;
 - (b) the Caspian Sea; or

⁴ See IMO Resolution A.1073(28) of December 4, 2013, "Recommendation on the Use of National Tonnage in Applying International Conventions". As described in this document, the Interim Schemes for Tonnage Measurement (Resolutions A.494(XII), A.540(13) and A.541(13)) effectively extended the use of national tonnages to certain other ships, for the purpose of applying relevant requirements of the SOLAS, STCW and MARPOL International Conventions.

⁵ The United States applies this interpretation to a U.S. flag vessel only when the vessel undergoes a change which necessitates remeasurement and cancellation of the International Tonnage Certificate (1969) under Article 10.

- (c) the Plate, Parana and Uruguay Rivers as far east as a rhumb line drawn between Punta Rasa (Cabo San Antonio), Argentina, and Punta del Este, Uruguay.

ARTICLE 5
FORCE MAJEURE

- (1) A ship which is not subject to the provisions of the present Convention at the time of its departure on any voyage shall not become subject to such provisions on account of any deviation from its intended voyage due to stress of weather or any other cause of force majeure.
- (2) In applying the provisions of the present Convention, the Contracting Governments shall give due consideration to any deviation or delay caused to any ship owing to stress of weather or any other cause of force majeure.

ARTICLE 6
DETERMINATION OF TONNAGES

The determination of gross and net tonnages shall be carried out by the Administration which may, however, entrust such determination either to persons or organizations recognized by it. In every case the Administration concerned shall accept full responsibility for the determination of gross and net tonnages.

ARTICLE 7
ISSUE OF CERTIFICATE

- (1) An International Tonnage Certificate (1969) shall be issued to every ship, the gross and net tonnages of which have been determined in accordance with the present Convention.
- (2) Such certificate shall be issued by the Administration or by any person or organization duly authorized by it. In every case, the Administration shall assume full responsibility for the certificate.

ARTICLE 8
ISSUE OF CERTIFICATE BY ANOTHER GOVERNMENT

- (1) A Contracting Government may, at the request of another Contracting Government, determine the gross and net tonnages of a ship and issue or authorize the issue of an International Tonnage Certificate (1969) to the ship in accordance with the present Convention.
- (2) A copy of the certificate and a copy of the calculations of the tonnages shall be transmitted as early as possible to the requesting Government.
- (3) A certificate so issued shall contain a statement to the effect that it has been issued at the request of the Government of the State whose flag the ship is or will be flying and it shall have the same validity and receive the same recognition as a certificate issued under Article 7.
- (4) No International Tonnage Certificate (1969) shall be issued to a ship which is flying the flag of a State the Government of which is not a Contracting Government.

ARTICLE 9
FORM OF CERTIFICATE

- (1) The certificate shall be drawn up in the official language or languages of the issuing country. If the language used is neither English nor French, the text shall include a translation into one of these languages.
- (2) The form of the certificate shall correspond to that of the model given in Annex II.

A.9(2)-1 The "Date" shown on the front of the International Tonnage Certificate (1969) refers to the year when the keel was laid or the ship was at a similar stage of construction (Article 2(6)) or the ship underwent alterations or modifications as defined in Article 3(2)(b) but when the year

of construction or alteration or modification is 1982 or 1994, the month and day should also be described.

- A.9(2)-2 *Information inserted in the "location" columns on the reverse of the International Tonnage Certificate (1969) should not be detailed.*
- A.9(2)-3 *The phrase "Date and place of original measurement" should refer to the issue of the original International Tonnage Certificate (1969) and should have no reference to measurement under pre-existing national systems.*
- A.9(2)-4 *The phrase "Date and place of last previous remeasurement" should refer to the date and place of issue of the last International Tonnage Certificate (1969) ⁶.*

ARTICLE 10 CANCELLATION OF CERTIFICATE

- (1) Subject to any exceptions provided in the Regulations, an International Tonnage Certificate (1969) shall cease to be valid and shall be cancelled by the Administration if alterations have taken place in the arrangement, construction, capacity, use of spaces, total number of passengers the ship is permitted to carry as indicated in the ship's passenger certificate, assigned load line or permitted draught of the ship, such as would necessitate an increase in gross tonnage or net tonnage.⁷
- (2) A certificate issued to a ship by an Administration shall cease to be valid upon transfer of such a ship to the flag of another State, except as provided in paragraph (3) of this Article.
- A.10(2)-1 *Ships holding an International Tonnage Certificate (1969), which do not comply with agreed interpretations of the provisions of the Convention, should be remeasured. The new characteristics should be determined and applied without delay.*
- (3) Upon transfer of a ship to the flag of another State the Government of which is a Contracting Government, the International Tonnage Certificate (1969) shall remain in force for a period not exceeding three months, or until the Administration issues another International Tonnage Certificate (1969) to replace it, whichever is the earlier. The Contracting Government of the State whose flag the ship was flying hitherto shall transmit to the Administration as soon as possible after the transfer takes place a copy of the certificate carried by the ship at the time of transfer and a copy of the relevant tonnage calculations.

ARTICLE 11 ACCEPTANCE OF CERTIFICATE

The certificate issued under the authority of a Contracting Government in accordance with the present Convention shall be accepted by the other Contracting Governments and regarded for all purposes covered by the present Convention as having the same validity as certificates issued by them.

ARTICLE 12 INSPECTION

- (1) A ship flying the flag of a State the Government of which is a Contracting Government shall be subject, when in the ports of other Contracting Governments, to inspection by officers duly authorized by such Governments. Such inspection shall be limited to the purpose of verifying:
- (a) that the ship is provided with a valid International Tonnage Certificate (1969); and

⁶ The United States applies this interpretation only in those instances where the International Tonnage Certificate (1969) was reissued to reflect a remeasurement, and not for administrative or other reasons, such as to reflect a name change.

⁷ The United States applies the interpretation that only those changes resulting in a tonnage increase or decrease of more than 5% to necessitate a remeasurement and cancellation of the International Tonnage Certificate (1969). (See § 69.9 of this MTN and § 1.3(b) of MTN 01-98 as amended.)

- (b) that the main characteristics of the ship correspond to the data given in the certificate.
- (2) In no case shall the exercise of such inspection cause any delay to the ship.
- (3) Should the inspection reveal that the main characteristics of the ship differ from those entered on the International Tonnage Certificate (1969) so as to lead to an increase in the gross tonnage or the net tonnage, the Government of the State whose flag the ship is flying shall be informed without delay.

A.12-1 A copy of the tonnage calculations may be provided together with the International Tonnage Certificate (1969) to the ship's master. Although not a requirement, nothing in the Convention would prevent Administrations from providing these calculations to ships flying their flag.

ARTICLE 13 PRIVILEGES

The privileges of the present Convention may not be claimed in favour of any ship unless it holds a valid certificate under the Convention.

ARTICLE 14 PRIOR TREATIES, CONVENTIONS AND ARRANGEMENTS

- (1) All other treaties, conventions and arrangements relating to tonnage matters at present in force between Governments Parties to the present Convention shall continue to have full and complete effect during the terms thereof as regards:
 - (a) ships to which the present Convention does not apply; and
 - (b) ships to which the present Convention applies, in respect of matters for which it has not expressly provided.
- (2) To the extent, however, that such treaties, conventions or arrangements conflict with the provisions of the present Convention, the provisions of the present Convention shall prevail.

ARTICLE 15 COMMUNICATION OF INFORMATION

The Contracting Governments undertake to communicate to and deposit with the Organization:

- (a) a sufficient number of specimens of their certificates issued under the provisions of the present Convention for circulation to the Contracting Governments;
- (b) the text of the laws, orders, decrees, regulations and other instruments which shall have been promulgated on the various matters within the scope of the present Convention; and
- (c) a list of non-governmental agencies which are authorized to act in their behalf in matters relating to tonnages for circulation to the Contracting Governments.

ARTICLE 16 SIGNATURE, ACCEPTANCE AND ACCESSION

- (1) The present Convention shall remain open for signature for six months from 23 June 1969, and shall thereafter remain open for accession. Governments of States Members of the United Nations, or of any of the Specialized Agencies, or of the International Atomic Energy Agency, or parties to the Statute of the International Court of Justice may become Parties to the Convention by:
 - (a) signature without reservation as to acceptance;
 - (b) signature subject to acceptance followed by acceptance; or

- (c) accession.
- (2) Acceptance or accession shall be effected by the deposit of an instrument of acceptance or accession with the Organization. The Organization shall inform all Governments which have signed the present Convention or acceded to it of each new acceptance or accession and of the date of its deposit. The Organization shall also inform all Governments which have already signed the Convention of any signature effected during the six months from 23 June 1969.

ARTICLE 17
COMING INTO FORCE

- (1) The present Convention shall come into force twenty-four months after the date on which not less than twenty-five Governments of States the combined merchant fleets of which constitute not less than sixty-five per cent of the gross tonnage of the world's merchant shipping have signed without reservation as to acceptance or deposited instruments of acceptance or accession in accordance with Article 16. The Organization shall inform all Governments which have signed or acceded to the present Convention of the date on which it comes into force.
- (2) For Governments which have deposited an instrument of acceptance of or accession to the present Convention during the twenty-four months mentioned in paragraph (1) of this Article, the acceptance or accession shall take effect on the coming into force of the present Convention or three months after the date of deposit of the instrument of acceptance or accession, whichever is the later date.
- (3) For Governments which have deposited an instrument of acceptance of or accession to the present Convention after the date on which it comes into force, the Convention shall come into force three months after the date of the deposit of such instrument.
- (4) After the date on which all the measures required to bring an amendment to the present Convention into force have been completed, or all necessary acceptances are deemed to have been given under subparagraph (b) of paragraph (2) of Article 18 in case of amendment by unanimous acceptance, any instrument of acceptance or accession deposited shall be deemed to apply to the Convention as amended.

ARTICLE 18
AMENDMENTS

- (1) The present Convention may be amended upon the proposal of a Contracting Government by any of the procedures specified in this Article.
- (2) Amendment by unanimous acceptance:
- (a) Upon the request of a Contracting Government, any amendment proposed by it to the present Convention shall be communicated by the Organization to all Contracting Governments for consideration with a view to unanimous acceptance.
- (b) Any such amendment shall enter into force twelve months after the date of its acceptance by all Contracting Governments unless an earlier date is agreed upon. A Contracting Government which does not communicate its acceptance or rejection of the amendment to the Organization within twenty-four months of its first communication by the latter shall be deemed to have accepted the amendment.
- (3) Amendment after consideration in the Organization:
- (a) Upon the request of a Contracting Government, any amendment proposed by it to the present Convention will be considered in the Organization. If adopted by a majority of two-thirds of those present and voting in the Maritime Safety Committee of the Organization, such amendment shall be communicated to all Members of the Organization and all Contracting Governments at least six months prior to its consideration by the Assembly of the Organization.

- (b) If adopted by a two-thirds majority of those present and voting in the Assembly, the amendment shall be communicated by the Organization to all Contracting Governments for their acceptance.
 - (c) Such amendment shall come into force twelve months after the date on which it is accepted by two-thirds of the Contracting Governments. The amendment shall come into force with respect to all Contracting Governments except those which, before it comes into force, make a declaration that they do not accept the amendment.
 - (d) The Assembly, by a two-thirds majority of those present and voting, including two-thirds of the Governments represented on the Maritime Safety Committee and present and voting in the Assembly, may propose a determination at the time of its adoption that an amendment is of such an important nature that any Contracting Government which makes a declaration under sub-paragraph (c) of this paragraph and which does not accept the amendment within a period of twelve months after it comes into force, shall cease to be a party to the present Convention upon the expiry of that period. This determination shall be subject to the prior acceptance of two-thirds of the Contracting Governments.
 - (e) Nothing in this paragraph shall prevent the Contracting Government which first proposed action under this paragraph on an amendment to the present Convention from taking at any time such alternative action as it deems desirable in accordance with paragraphs (2) or (4) of this Article.
- (4) Amendment by a conference:
- (a) Upon the request of a Contracting Government, concurred in by at least one-third of the Contracting Governments, a conference of Governments will be convened by the Organization to consider amendments to the present Convention.
 - (b) Every amendment adopted by such a conference by a two-thirds majority of those present and voting of the Contracting Governments shall be communicated by the Organization to all Contracting Governments for their acceptance.
 - (c) Such amendment shall come into force twelve months after the date on which it is accepted by two-thirds of the Contracting Governments. The amendment shall come into force with respect to all Contracting Governments except those which, before it comes into force, make a declaration that they do not accept the amendment.
 - (d) By a two-thirds majority of those present and voting, a conference convened under sub-paragraph (a) of this paragraph may determine at the time of its adoption that an amendment is of such an important nature that any Contracting Government which makes a declaration under sub-paragraph (c) of this paragraph, and which does not accept the amendment within a period of twelve months after it comes into force, shall cease to be a party to the present Convention upon the expiry of that period.
- (5) The Organization shall inform all Contracting Governments of any amendments which may come into force under this Article, together with the date on which each such amendment will come into force.
- (6) Any acceptance or declaration under this Article shall be made by the deposit of an instrument with the Organization which shall notify all Contracting Governments of the receipt of the acceptance or declaration.

ARTICLE 19
DENUNCIATION

- (1) The present Convention may be denounced by any Contracting Government at any time after the expiry of five years from the date on which the Convention comes into force for that Government.
- (2) Denunciation shall be effected by the deposit of an instrument with the Organization which shall inform all the other Contracting Governments of any such denunciation received and of the date of its receipt.
- (3) A denunciation shall take effect one year, or such longer period as may be specified in the instrument of denunciation, after its receipt by the Organization.

**ARTICLE 20
TERRITORIES**

- (1) (a) The United Nations, in cases where they are the administering authority for a territory, or any Contracting Government responsible for the international relations of a territory, shall as soon as possible consult with such territory or take such measures as may be appropriate in an endeavour to extend the present Convention to that territory and may at any time by notification in writing to the Organization declare that the present Convention shall extend to such territory.

(b) The present Convention shall, from the date of receipt of the notification or from such other date as may be specified in the notification, extend to the territory named therein.
- (2) (a) The United Nations, or any Contracting Government which has made a declaration under subparagraph (a) of paragraph (1) of this Article at any time after the expiry of a period of five years from the date on which the Convention has been so extended to any territory, may by notification in writing to the Organization declare that the present Convention shall cease to extend to any such territory named in the notification.

(b) The present Convention shall cease to extend to any territory mentioned in such notification one year, or such longer period as may be specified therein, after the date of receipt of the notification by the Organization.
- (3) The Organization shall inform all the Contracting Governments of the extension of the present Convention to any territories under paragraph (1) of this Article, and of the termination of any such extension under the provisions of paragraph (2) stating in each case the date from which the present Convention has been or will cease to be so extended.

**ARTICLE 21
DEPOSIT AND REGISTRATION**

- (1) The present Convention shall be deposited with the Organization and the Secretary-General of the Organization shall transmit certified true copies thereof to all Signatory Governments and to all Governments which accede to the present Convention.
- (2) As soon as the present Convention comes into force, the text shall be transmitted by the Secretary-General of the Organization to the Secretariat of the United Nations for registration and publication, in accordance with Article 102 of the Charter of the United Nations.

**ARTICLE 22
LANGUAGES**

The present Convention is established in a single copy in the English and French languages, both texts being equally authentic. Official translations in the Russian and Spanish languages shall be prepared and deposited with the signed original.

IN WITNESS WHEREOF the undersigned being duly authorized by their respective Governments for that purpose have signed the present Convention.

DONE at London this twenty-third day of June 1969.

ANNEX I REGULATIONS FOR DETERMINING GROSS AND NET TONNAGES OF SHIPS

REGULATION 1 GENERAL

- (1) The tonnage of a ship shall consist of gross tonnage and net tonnage.
- (2) The gross tonnage and the net tonnage shall be determined in accordance with the provisions of these Regulations.
- (3) The gross tonnage and the net tonnage of novel types of craft whose constructional features are such as to render the application of the provisions of these Regulations unreasonable or impracticable shall be as determined by the Administration.⁸ Where the tonnage is so determined, the Administration shall communicate to the Organization details of the method used for that purpose, for circulation to the Contracting Governments for their information.

R.1(3)-1 In applying these novel craft provisions, the resulting gross and net tonnages should be reflective of the ship's overall size and useful capacity, respectively. A novel type of craft should be understood as one which is novel in its design and should not include existing traditional types of ships of usual shape or those types already covered by the Unified interpretations.

REGULATION 2 DEFINITIONS OF TERMS USED IN THE ANNEXES

(1) Upper Deck

The upper deck is the uppermost complete deck exposed to weather and sea, which has permanent means of weathertight closing of all openings in the weather part thereof, and below which all openings in the sides of the ship are fitted with permanent means of watertight closing. In a ship having a stepped upper deck, the lowest line of the exposed deck and the continuation of that line parallel to the upper part of the deck is taken as the upper deck.⁹

R.2(1)-1 A discontinuity in the upper deck which extends over the full breadth of the ship and is in excess of 1 m in length should be treated as a step as defined in Regulation 2(1).

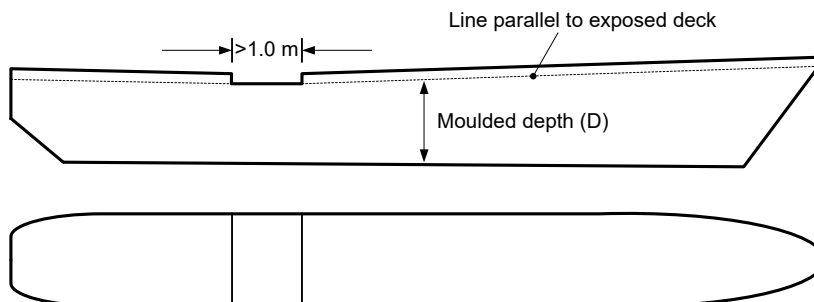

R.2(1)-2 Steps situated outside the "length" (Article 2(8)) should not be considered.¹⁰

⁸ The novel craft interpretations of Circular TM.5/Circ.6 are included as a separate section following Annex II of this MTN reprint of the 1969 Tonnage Convention.

⁹ See Interpretations R.2(1)-5 and R.2(8)-U1 for the meanings of the terms "watertight" and "weathertight".

¹⁰ The United States applies this interpretation with the understanding that for a step that is partially outside the "length" to be considered, the portion inside the "length" must extend at least 1 m.

R.2(1)-3 A discontinuity in the upper deck which does not extend to the side of the ship should be treated as a recess under the upper deck level.

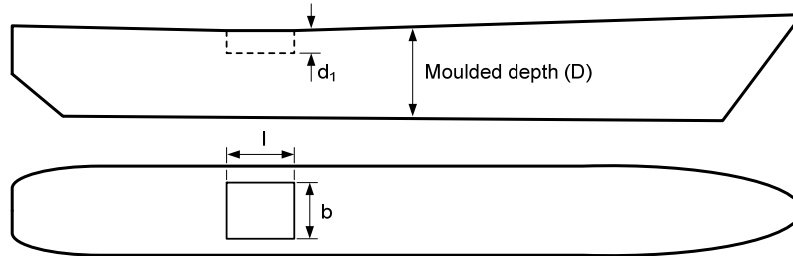

R.2(1)-4 In a ship having openings in the side of the ship below the uppermost deck, which are not closed but limited inboard by weathertight bulkheads and decks, the deck below such openings should be considered the upper deck.

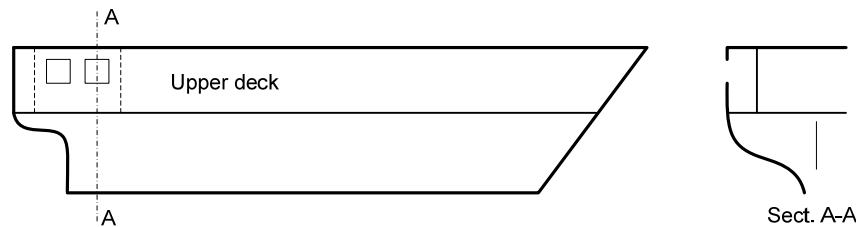

R.2(1)-5 The Administration may decide on the term "watertight" as a special definition for tonnage purposes is not needed.¹¹

(2) Moulded Depth

(a) The moulded depth is the vertical distance measured from the top of the keel to the underside of the upper deck at side. In wood and composite ships the distance is measured from the lower edge of the keel rabbet. Where the form at the lower part of the midship section is of a hollow character, or where thick garboards are fitted, the distance is measured from the point where the line of the flat of the bottom continued inwards cuts the side of the keel.

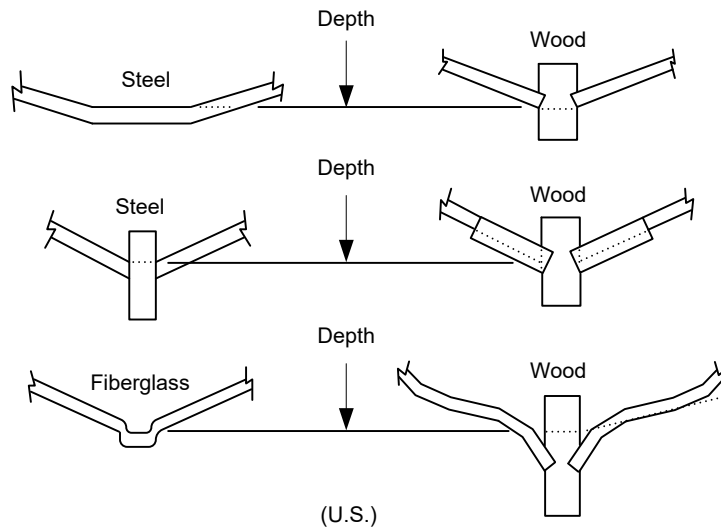

¹¹ The United States applies the interpretation that "watertight" means capable of preventing the passage of water through the structure or closure in any direction under a head of water for which the surrounding structure is designed.

- (b) In ships having rounded gunwales, the moulded depth shall be measured to the point of intersection of the moulded lines of the deck and side shell plating, the lines extending as though the gunwales were of angular design.

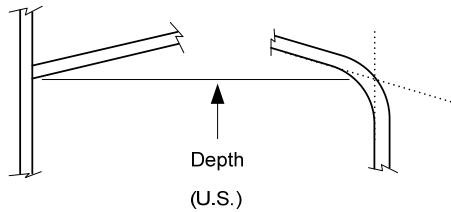

- (c) Where the upper deck is stepped and the raised part of the deck extends over the point at which the moulded depth is to be determined, the moulded depth shall be measured to a line of reference extending from the lower part of the deck along a line parallel with the raised part.

R.2(2)-I1 (IACS) When calculating the net tonnage for ships with an open mooring deck aft, the moulded depth should be measured to the line of the open mooring deck continued forward parallel to the raised part of the upper deck (depth D1 in Figure 1) and not to the raised part of the upper deck (depth D2 in Figure 1). If the upper deck is continued aft over the mooring deck, the moulded depth should still be taken as D1 in Figure 1, provided that the side openings allow the space below the upper deck to be considered as an excluded space according to Regulation 2 (5) (b) and (c).

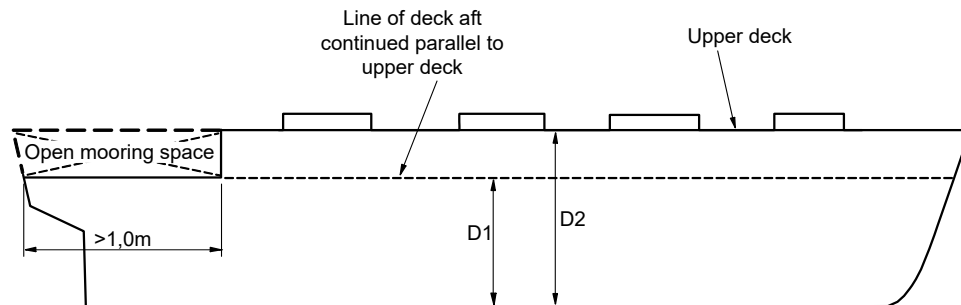

Fig. 1
 (IACS)

For ships with a step in the upper deck extending across the full breadth and greater than one metre in length, the moulded depth should be measured to the line of the lower point of the exposed deck extended parallel to the raised part of the exposed deck (depth D1 in Figure 2) and not to the raised part of the upper deck (depth D2 in Figure 2).

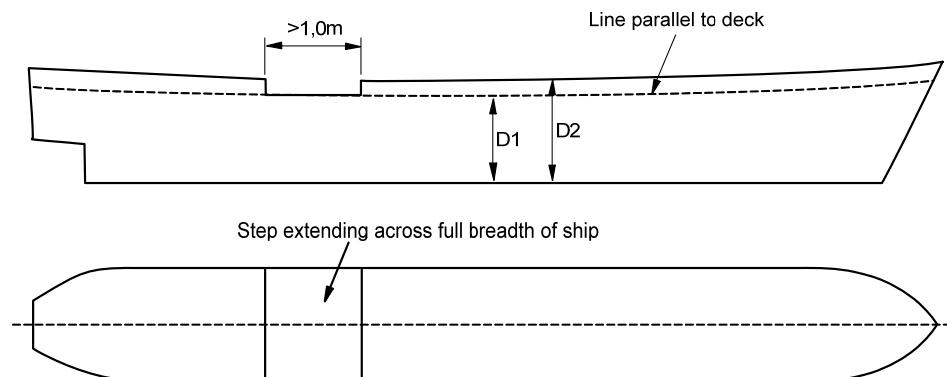

Fig. 2
 (IACS)

If the step or mooring deck is situated outside the length as defined in Article 2(8) of the Convention or if the length of the step or mooring deck is one metre or less, the moulded depth should be taken as D2 in Figures 1 and 2.

R.2(2)-U1 For vessels that are not monohulls (e.g., catamarans, trimarans, SWATH's), the (U.S.) registered depth is the moulded depth of the deepest hull(s).

(3) Breadth

The breadth is the maximum breadth of the ship, measured amidships to the moulded line of the frame in a ship with a metal shell and to the outer surface of the hull in a ship with a shell of any other material.

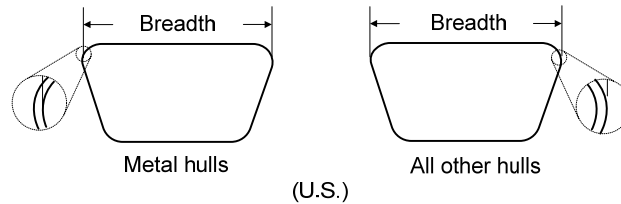

R.2(3)-1 The term "amidships" should be considered as the midpoint of the length as defined in Article 2(8) where the forward terminal of that length coincides with the fore side of the stem.

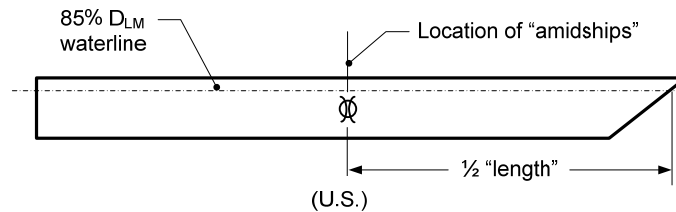

(4) Enclosed Spaces

Enclosed spaces are all those spaces which are bounded by the ship's hull, by fixed or portable partitions or bulkheads, by decks or coverings other than permanent or movable awnings¹². No break in a deck, nor any opening in the ship's hull, in a deck or in a covering of a space, or in the partitions or bulkheads of a space, nor the absence of a partition or bulkhead, shall preclude a space from being included in the enclosed space.

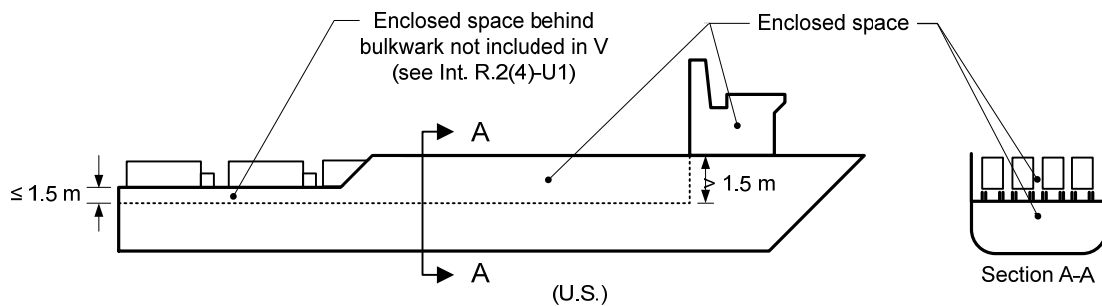

R.2(4)-1 In Regulation 2(4) there is no contradiction between the definition of enclosed spaces as being "bounded by the ship's hull, by fixed or portable partitions ..." and "... nor the absence of a partition or bulkhead, shall preclude a space from being included in the enclosed space".

¹² United States tonnage regulations provide for space that is bounded by the ship's hull, by fixed or portable partitions or bulkheads, or by decks or coverings other than permanent or removable awnings to be treated as enclosed. (See Interpretation R.2(4)-U1.)

R.2(4)-2 Space located within the boundaries of “permanent or movable awnings” should be subject to treatment under Regulation 2(5).

Awning (i.e., overhead covering comprised of a flexible nonmetallic material stretched over a frame).

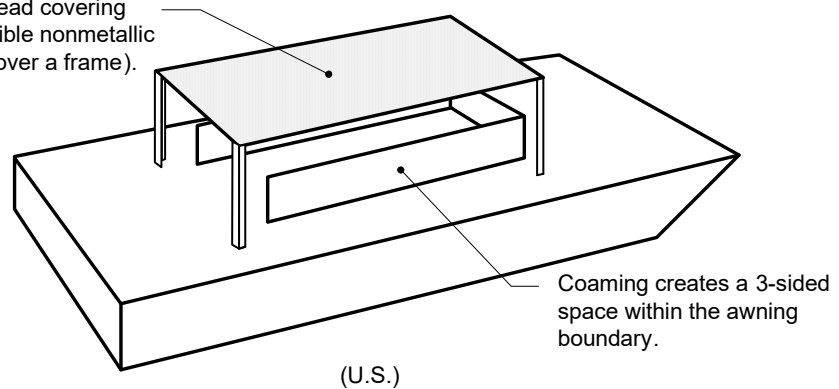

R.2(4)-3 Tanks, permanently located on the upper deck, provided with removable pipe connections to the cargo system or the vent (de-airing) lines of the ship, should be included in V_c .¹³

R.2(4)-4 The volume of weathertight steel pontoon covers on hatchway coamings should be included in the calculations of the total volume (V) of the ship. If such covers are open on the underside, their volume should also be included in V_c .

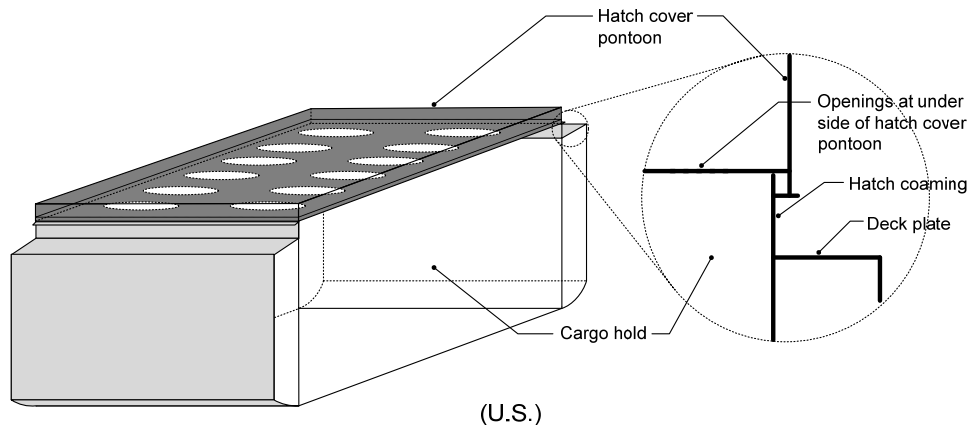

R.2(4)-5 Multipurpose ships which have the facility to trade with cargo hatches open or closed should always be measured with the hatch covers considered to be closed.

¹³ The United States applies this interpretation with the understanding that such tanks should be considered for inclusion in tonnage regardless of duration and method of attachment. (See Interpretation R.2(4)-U2.)

- R.2(4)-6 *Masts, kingposts, cranes, crane and container support structures, which are completely inaccessible and above the upper deck, separated on all their sides from other enclosed spaces should not be included in the total volume of all enclosed spaces. Air trunks having a cross-sectional area not exceeding 1 m² may also be excluded under the before-mentioned conditions.*

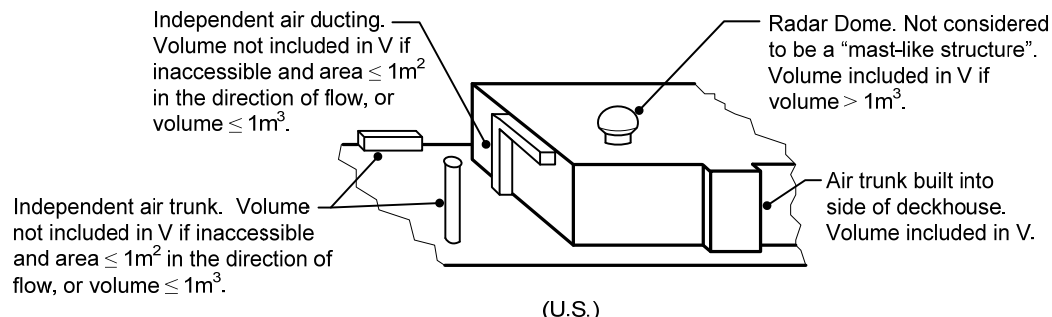

- R.2(4)-7 *If enclosed spaces comply with the conditions for exclusion specified in Regulation 2(5), then they should be excluded from the total volume of all enclosed spaces (V). Such spaces should be treated as “enclosed but excluded spaces” to differentiate from “enclosed and included spaces” (those “enclosed spaces” which do not comply with the conditions for exclusion specified in Regulation 2(5)).*

- R.2(4)-8 *Open gratings that are part of the ship's hull, or of any deck, covering, partition or bulkhead, are not considered to bound enclosed space, and are ignored when applying this Regulation.¹⁴*

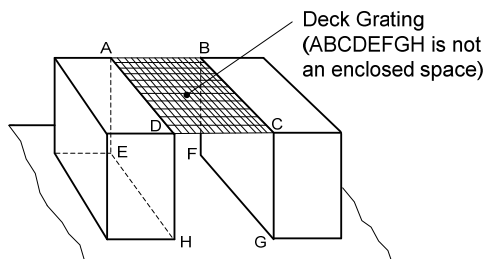

- R.2(4)-9 *Machinery such as mooring and towing equipment, winches, revolving cranes, cranes with truss structures, and other similar items should not be included in the total volume of all enclosed spaces (V).¹⁵*

- R.2(4)-10 *Mobile cranes should not be included in the total volume of all enclosed spaces (V). “Mobile” means that the main structure (support) of the crane moves either longitudinally or transversely relative to the ship.*

- R.2(4)-11 (IACS) *Heat exchangers (coolers) fitted in hull recesses or outside of the hull shall be treated as machinery under TM.5/Circ.6 Interpretation R.2(4)-9 and not as appendages.¹⁶*

¹⁴ The United States applies this interpretation with the understanding that deck boards with drainage gaps, as typically used in raised working deck configurations, do not constitute open gratings in this context.

¹⁵ The United States applies this interpretation with the understanding that “machinery” includes those installations that themselves are not bounded by bulkheads, or partitions that otherwise bound enclosed space. The volumes of housed machinery installations such as fully enclosed generator units are included in tonnage. Unhoused deck winches, movable lift boat support legs, rudders, propeller shafting, propellers, azimuthing propulsion units, and other movable propulsion, steering or trimming devices are considered machinery in this context.

¹⁶ The United States applies this interpretation with the understanding that it applies only to installations where the heat exchanger consists of piping or similar.

R.2(4)-U1 (U.S.) *A space, bounded by a deck or similar, either above or below, or enclosed by partitions or bulkheads on all sides or on all but a single side or end, that exceed 1.5 metres (5 feet) in height, as measured from the lowest point of the space is an enclosed space. In the situation where only a portion of the bulkhead or partition exceeds 1.5 metres (5 feet) in height, the entire inboard space in way of that portion of the structure from the deck to the top of the structure is treated as an enclosed space.*

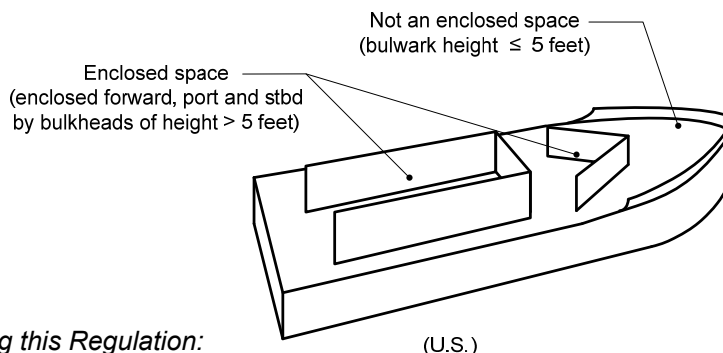

R.2(4)-U2 (U.S.) *In applying this Regulation:*

- .1 *Portable enclosed spaces (sometimes referred to as “temporary deck equipment”) are treated as enclosed spaces. A portable enclosed space is an enclosed space that is not deck cargo, and whose method of attachment to the vessel is not permanent in nature. Examples of portable enclosed spaces include modular living quarters, housed portable machinery spaces, and deck tanks used in support of shipboard industrial processes.*
- .2 *Deck cargo means freight carried on the weather decks of a vessel for the purpose of its transport between two separate and distinct locations, and which is off-loaded from the vessel in its original container (if applicable) without undergoing any processing or other use while onboard the vessel. Deck cargo is not included in tonnage.*

(5) Excluded Spaces

Notwithstanding the provisions of paragraph (4) of this Regulation, the spaces referred to in subparagraphs (a) to (e) inclusive of this paragraph shall be called excluded spaces and shall not be included in the volume of enclosed spaces, except that any such space which fulfils at least one of the following three conditions shall be treated as an enclosed space:

- the space is fitted with shelves or other means for securing cargo or stores;
- the openings are fitted with any means of closure;
- the construction provides any possibility of such openings being closed:

- (a)(i) A space within an erection opposite an end opening extending from deck to deck except for a curtain plate of a depth not exceeding by more than 25 millimetres (one inch) the depth of the adjoining deck beams, such opening having a breadth equal to or greater than 90 per cent of the breadth of the deck at the line of the opening of the space. This provision shall be applied so as to exclude from the enclosed spaces only the space between the actual end opening and a line drawn parallel to the line or face of the opening at a distance from the opening equal to one half of the width of the deck at the line of the opening (Figure 1 in Appendix 1).

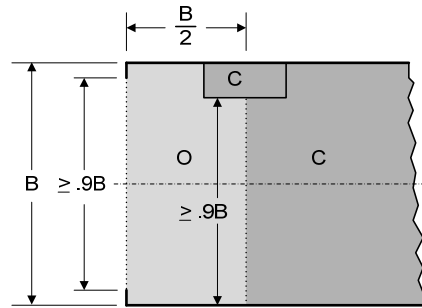

Fig. 1

R.2(5)(a)(i)-U1 (U.S.) If an end opening is protected from the weather by an overhanging roof or similar covering, the "one-half the breadth" set-in requirements of this section are applied by measuring to the outermost edge of the covering.

- (a)(ii) Should the width of the space because of any arrangement except by convergence of the outside plating, become less than 90 per cent of the breadth of the deck, only the space between the line of the opening and a parallel line drawn through the point where the athwartships width of the space becomes equal to, or less than, 90 per cent of the breadth of the deck shall be excluded from the volume of enclosed spaces (Figures 2, 3 and 4 in Appendix 1).

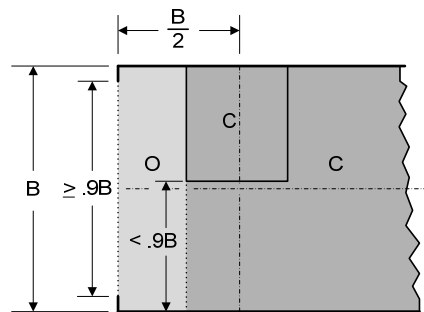

Fig. 2

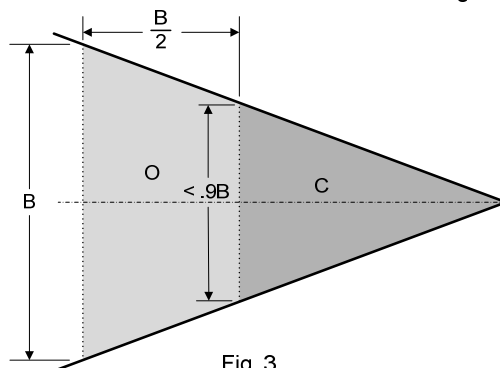

Fig. 3

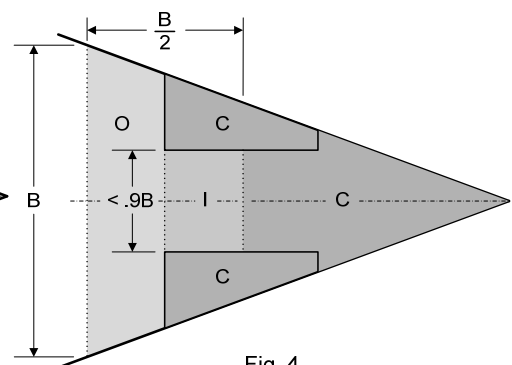
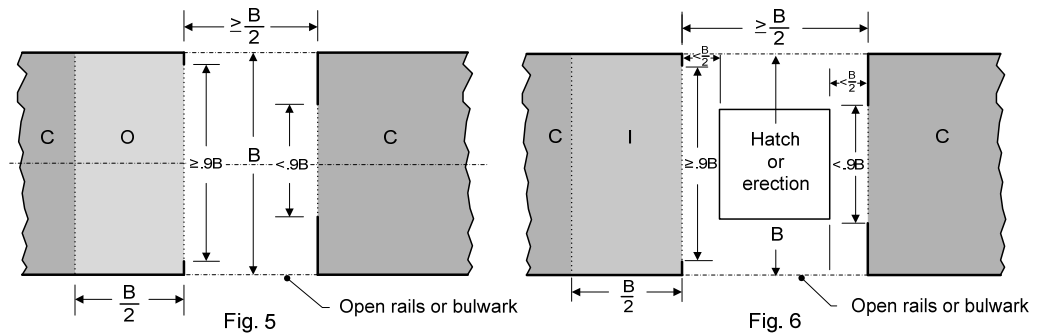
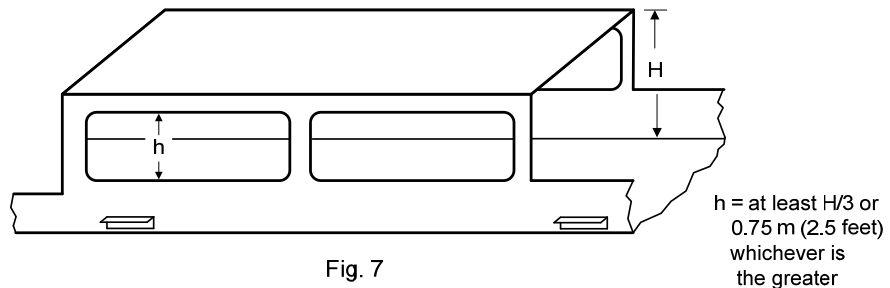

Fig. 4

- (a)(iii) Where an interval which is completely open except for bulwarks or open rails separates any two spaces, the exclusion of one or both of which is permitted under sub-paragraphs (a)(i) and/or (a)(ii), such exclusion shall not apply if the separation between the two spaces is less than the least half breadth of the deck in way of the separation (Figures 5 and 6 in Appendix 1).



- (b) A space under an overhead deck covering open to the sea and weather, having no other connexion on the exposed sides with the body of the ship than the stanchions necessary for its support. In such a space, open rails or a bulwark and curtain plate may be fitted or stanchions fitted at the ship's side, provided that the distance between the top of the rails or the bulwark and the curtain plate is not less than 0.75 metres (2.5 feet) or one-third of the height of the space, whichever is the greater (Figure 7 in Appendix 1).



- (c) A space in a side-to-side erection directly in way of opposite side openings not less in height than 0.75 metres (2.5 feet) or one-third of the height of the erection, whichever is the greater. If the opening in such an erection is provided on one side only, the space to be excluded from the volume of enclosed spaces shall be limited inboard from the opening to a maximum of one-half of the breadth of the deck in way of the opening (Figure 8 in Appendix 1).

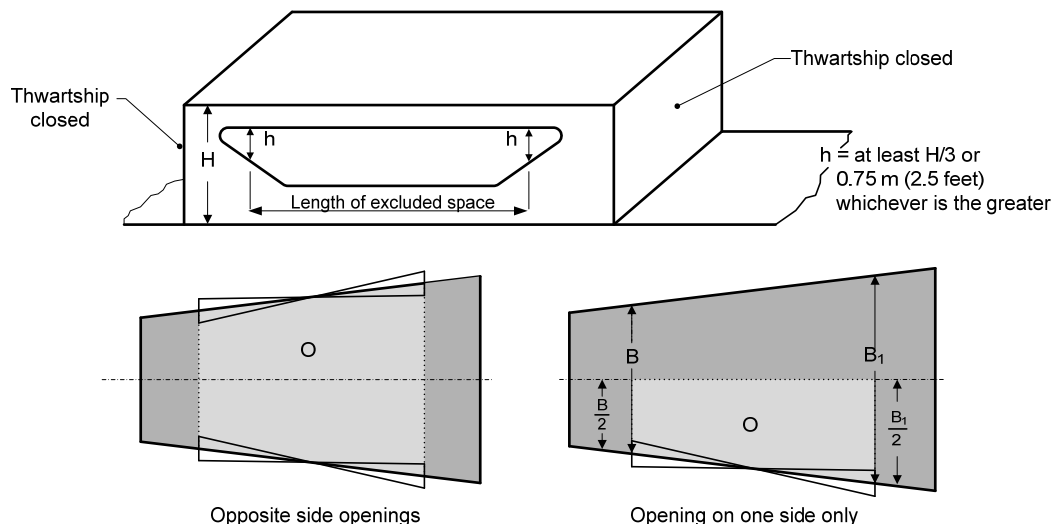

Fig. 8

- (d) A space in an erection immediately below an uncovered opening in the deck overhead, provided that such an opening is exposed to the weather and the space excluded from enclosed spaces is limited to the area of the opening (Figure 9 in Appendix 1)

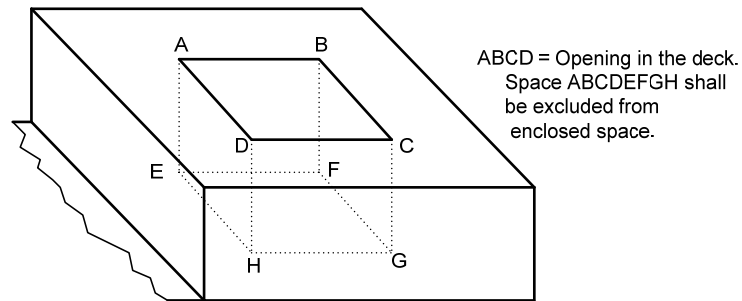
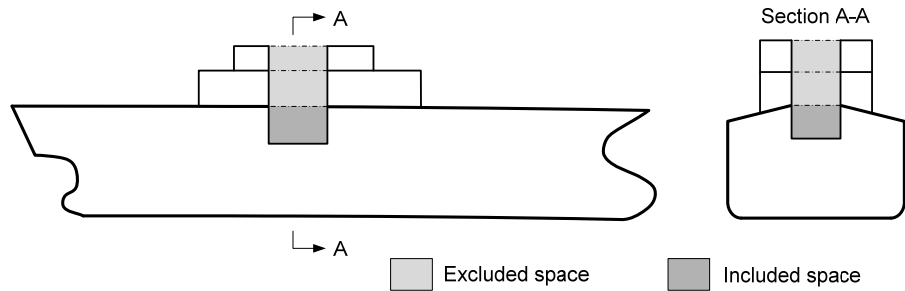

Fig. 9

- R.2(5)(d)-1 *The term "immediately below" means extending from the deck in which the opening occurs to the lower boundary of the opening being considered. Openings which penetrate the upper deck (as defined in Regulation 2(1)) are only excluded to the line of the upper deck.*



- (e) A recess in the boundary bulkhead of an erection which is exposed to the weather and the opening of which extends from deck to deck without means of closing, provided that the interior width is not greater than the width at the entrance and its extension into the erection is not greater than twice the width of its entrance (Figure 10 in Appendix 1).

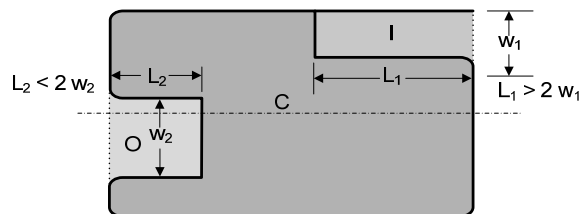
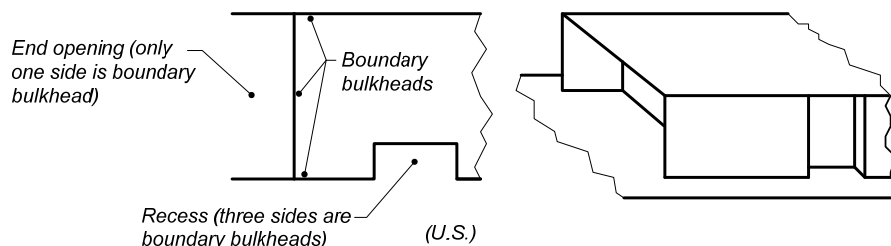

Fig. 10

R.2(5)(e)-U1 (U.S.) The term “boundary bulkhead” means the bulkhead or partition that separates an interior space from the surrounding weather. In general, the exterior bulkhead of a deck structure is the boundary bulkhead. The term “recess in the boundary bulkhead” means an exterior space that is bounded on at least 2 sides by connecting boundary bulkheads.



R.2(5)(e)-U2 (U.S.) In order for the opening of a covered recess to be considered to extend from deck to deck, the depth of any curtain plate at the entrance of the recess cannot exceed by more than 25 millimeters (one inch) the depth of the adjoining deck beams.

R.2(5)-1 The space between the side longitudinal bulkhead of a deckhouse and the bulwark below a deck extending from side to side supported by stanchions or vertical plates connected to the bulwarks, should be treated as an excluded space in accordance with Regulation 2(5)(b) and (c). Similarly, open spaces directly below a bridge wing structure should not be treated as enclosed spaces.

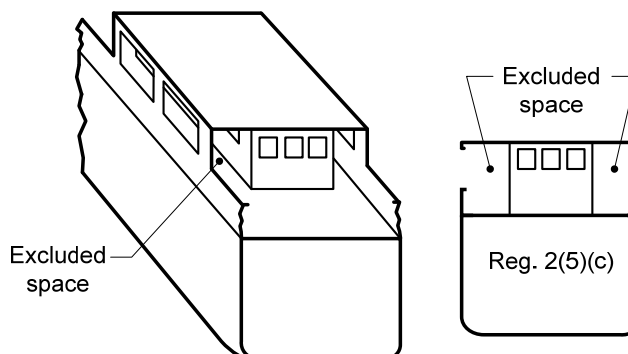

R.2(5)-2 In the case of a ro-ro ship, for example, where the space at the end of an erection is fitted with means for securing cargo, the space should be included in V in accordance with the first condition of Regulation 2(5).

R.2(5)-3 In applying this Regulation:

- .1 spaces excluded from the total volume of all enclosed spaces (V) are those spaces which are treated as enclosed ones under Regulation 2(4) but also comply with the conditions for exclusion under Regulation 2(5);
- .2 the volume of those enclosed spaces referred to in Regulation 2(5)(a) to (e) shall be excluded from the total volume of all enclosed spaces (V), unless at least one of the following three conditions takes place:
 - the space is fitted with any means for securing cargo or stores;
 - the openings are fitted with any means of closure;
 - the construction provides any possibility of such openings being closed.

R.2(5)-4 In Appendix 1 to the Convention, labeling in the figures shall be interpreted as follows:

- .1 “O = excluded space” refers to an enclosed space or part of an enclosed space which corresponds to one of the situations described in Regulation 2(5)(a) to (e) and which satisfies the conditions for exclusion from the total volume of all enclosed spaces (V) specified in this Regulation;
- .2 “C = enclosed space” refers to an enclosed space or part of an enclosed space which does not correspond to any of the situations described in Regulation 2(5)(a) to (e) and consequently can never be excluded from the total volume of all enclosed spaces (V);
- .3 “I = space to be considered as an enclosed space” refers to an enclosed space or part of an enclosed space which corresponds to one of the situations described in Regulation 2(5)(a) to (e) but does not satisfy the conditions for exclusion from the total volume of all enclosed spaces (V) specified in this Regulation.

R.2(5)-5 In applying Regulation 2(5)(b) and (c), stanchions necessary to support an overhead deck and vertical railings are not considered to close or reduce the size of a side opening. Horizontal bars connecting vertical railings should not be treated as rails as described in Regulation 2(5)(b).

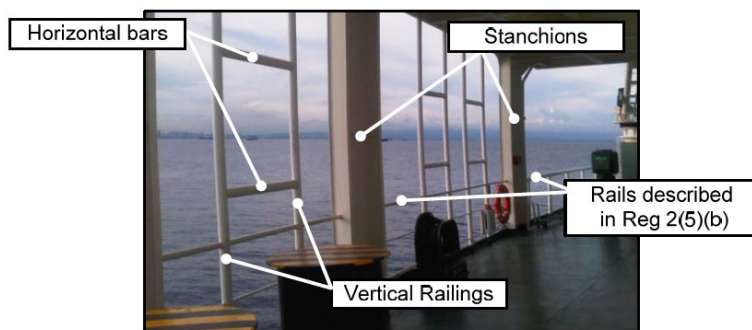

R.2(5)-6 When applying the provisions of Regulation 2(5), the phrase “breadth of the deck” means the breadth of the deckhouse structure at the line of the opening of the space, regardless of whether or not the structure extends from side to side. In addition to erections extending from side to side, the requirements for excluded spaces under Regulation 2(5) are also applicable to structures that do not extend from side to side of the ship. In such structures B means breadth of a structure that does not extend from side to side, measured in way of the opening. (See appendix 1 to the Convention.)

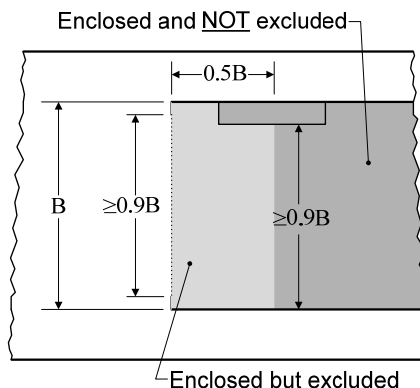

R.2(5)-7 Grates covering side or end openings should not be considered as means of closure when applying this Regulation.

R.2(5)-U1 (U.S.) A space is considered to be “fitted with shelves or other means for securing cargo or stores” only if the securing means are designed for this purpose (e.g., stanchions, fences and railings for restraining livestock, vehicle tie-downs, etc.). In this context, the term “stores” refers to provisions (food), paint, ropes and other supplies necessary for the operation of a

vessel and the maintenance of its crew. Stores do not include passenger benches/seats and shelves/racks for safety equipment, such as fire extinguishers, life jackets, and life rafts.

R.2(5)-U2 (U.S.) In applying Regulation 2(5), bulwark means that part of a vessel's side above the upper deck that serves to protect the upper deck from exposure to the sea. Structures above the upper deck at the vessel's side that contain enclosed volume are not bulwarks, but rather are considered as superstructure spaces.

(6) Passenger

A passenger is every person other than:

- (a) the master and the members of the crew or other persons employed or engaged in any capacity on board a ship on the business of that ship; and
- (b) a child under one year of age.

R.2(6)-1 N_1 and N_2 should be obtained from the Administration's maritime safety authority.

(7) Cargo Spaces

Cargo spaces to be included in the computation of net tonnage are enclosed spaces appropriated for the transport of cargo which is to be discharged from the ship, provided that such spaces have been included in the computation of gross tonnage. Such cargo spaces shall be certified by permanent marking with the letters CC (cargo compartment) to be so positioned that they are readily visible and not to be less than 100 millimetres (4 inches) in height.

R.2(7)-1 *The volumes of the segregated ballast tanks should not be included in V_c provided they are not to be used for cargo.*

R.2(7)-2 *The volumes of clean ballast tanks in oil tankers should be included in V_c when the ship is fitted with a crude oil washing system which would permit dual purpose cargo/clean ballast tank use of these tanks.*

R.2(7)-3 *The volumes of dedicated clean ballast tanks should not be included in V_c provided that:*

- .1 *the tanks are not used for cargo;*
- .2 *the ship carries a single IOPP Certificate which indicates it is operating with dedicated clean ballast tanks in accordance with Regulation 13A, Annex I, MARPOL 73/78;*
- .3 *the following notation is inserted in the REMARKS column on the International Tonnage Certificate (1969): "This ship carries an IOPP Certificate in conformity with regulation 13A, Annex I, MARPOL 73/78. The following tanks are dedicated solely to the carriage of clean ballast water: _____."*

R.2(7)-4 *The volumes of slop tanks for cargo residues should be included in V_c .*

R.2(7)-5 *In fishing vessels, the volumes of fish processing spaces for fishmeal, liver oil and canning, tanks for re-cooling fish, wet fish bunkers, stores for salt, spices, oil and tare should be included in V_c . Fishing gear stores should not be included in V_c .*

R.2(7)-6 *The volume of refrigerating machinery used for refrigerating cargoes and situated within the boundaries of the cargo spaces should be included in V_c .*

R.2(7)-7 *The volumes of mail rooms, baggage compartments separate from passenger accommodation, and bonded stores for passengers should be included in V_c . The volume of provision rooms for crew or passengers and bonded stores for crew should not be included in V_c .*

R.2(7)-8 On combination carriers, where the owners request to have the dual purpose oil/ballast tanks converted to ballast tanks and excluded from V_c , the ballast tanks should be required to be permanently disconnected from the oil cargo system and not used for the carriage of cargo. The ship should then be remeasured in accordance with Regulation 5(3). Any ballast tanks not to be included in V_c should be solely allocated to ballast, connected to an independent ballast system, and not used to carry cargo.

R.2(7)-9 When determining the volumes of cargo spaces, no account should be taken of insulation, sparring or ceiling which is fitted within the boundaries of the space concerned. For ships which have permanent independent cargo tanks constructed within the ship, e.g. gas tankers, the volume to be included in V_c should be calculated to the structural boundary of such tanks, irrespective of insulation which may be fitted on the inside or outside of the tank boundary.

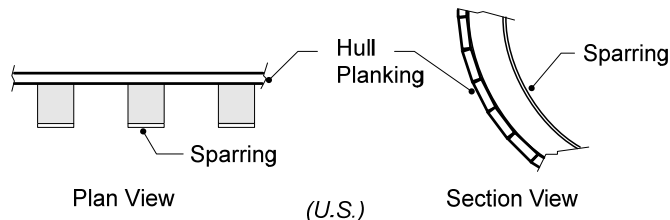

R.2(7)-10 The volumes of dual purpose spaces such as those used for both ballast and cargo should be included in V_c .¹⁷

R.2(7)-11 Spaces allocated to passenger automobiles should be included in V_c .

R.2(7)-U1 Cargo spaces within a hopper or similar structure on deck barges should be included in V_c . Per Interpretation R.2(4)-U1, these spaces are ignored from volume calculations if the height of the hopper above the deck does not exceed 5 feet (1.5 meters).

(8) **Weathertight**

Weathertight means that in any sea conditions water will not penetrate into the ship.

R.2(8)-U1 The United States interprets the term "weathertight" to mean in any sea conditions water will not penetrate into the ship, including intermittent immersion such as wave action and spray.

(9) **Audit**

Audit means a systematic, independent and documented process for obtaining audit evidence and evaluating it objectively to determine the extent to which audit criteria are fulfilled.

(10) **Audit Scheme**

Audit Scheme means the IMO Member State Audit Scheme established by the Organization and taking into account the guidelines developed by the Organization.

(11) **Code for Implementation**

Code for Implementation means the IMO Instruments Implementation Code (III Code) adopted by the Organization by resolution A.1070(28).

(12) **Audit Standard**

Audit Standard means the Code for Implementation.

¹⁷ The United States applies this interpretation with the understanding that it refers only to dual purpose spaces which carry cargo at any time.

**REGULATION 3
GROSS TONNAGE**

The gross tonnage (GT) of a ship shall be determined by the following formula:

$$GT = K_1 V$$

where: V = Total volume of all enclosed spaces of the ship in cubic metres,
 K_1 = $0.2 + 0.02 \log_{10} V$ (or as tabulated in Appendix 2).

R.3-1 *The K_1 coefficient used in the gross tonnage calculation may be derived from either the table in appendix 2 of the Convention or from the formula in Regulation 3 at the discretion of the Administration.*

R.3-2 *The final tonnage figure determined in accordance with Regulation 3 and stated in the tonnage certificate should be given in rounded down figures without decimals.*

**REGULATION 4
NET TONNAGE**

R.4-1 *The K_2 coefficient used in the net tonnage calculation may be derived from either the table in appendix 2 of the Convention or from the formula in Regulation 4 at the discretion of the Administration.*

R.4-2 *The final tonnage figure determined in accordance with Regulation 4 and stated in the tonnage certificate should be given in rounded down figures without decimals.*

(1) The net tonnage (NT) of a ship shall be determined by the following formula:

$$NT = K_2 V_c \left(\frac{4d}{3D} \right)^2 + K_3 \left(N_1 + \frac{N_2}{10} \right),$$

in which formula:

(a) the factor $\left(\frac{4d}{3D} \right)^2$ shall not be taken as greater than unity;

(b) the term $K_2 V_c \left(\frac{4d}{3D} \right)^2$ shall not be taken as less than 0.25 GT; and

(c) NT shall not be taken as less than 0.30 GT, and in which:

V_c = total volume of cargo spaces in cubic metres,

K_2 = $0.2 + 0.02 \log_{10} V_c$ (or as tabulated in Appendix 2),

K_3 = $1.25 \frac{GT+10,000}{10,000}$,

D = moulded depth amidships in metres as defined in Regulation 2(2),

d = moulded draught amidships in metres as defined in paragraph (2) of this Regulation,

N_1 = number of passengers in cabins with not more than 8 berths,

N_2 = number of other passengers,

$N_1 + N_2$ = total number of passengers the ship is permitted to carry as indicated in the ship's passenger certificate; when $N_1 + N_2$ is less than 13, N_1 and N_2 shall be taken as zero,

GT = gross tonnage of the ship as determined in accordance with the provisions of Regulation 3.

(2) The moulded draught (d) referred to in paragraph (1) of this Regulation shall be one of the following draughts:

(a) for ships to which the International Convention on Load Lines in force applies, the draught corresponding to the Summer Load Line (other than timber load lines) assigned in accordance with that Convention;

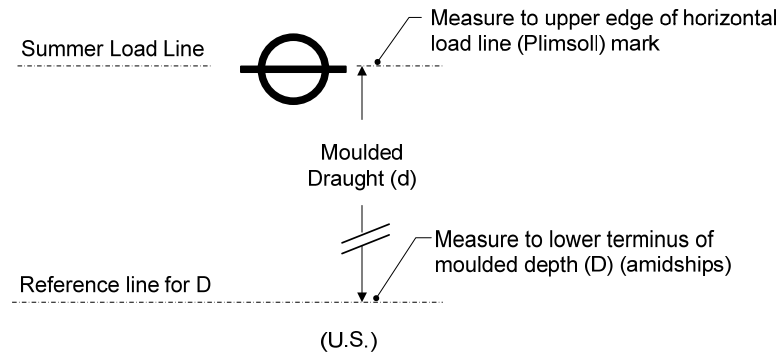

(b) for passenger ships, the draught corresponding to the deepest subdivision load line assigned in accordance with the International Convention for the Safety of Life at Sea in force or other international agreement where applicable;

(c) for ships to which the International Convention on Load Lines does not apply but which have been assigned a load line in compliance with national requirements, the draught corresponding to the summer load line so assigned;

(d) for ships to which no load line has been assigned but the draught of which is restricted in compliance with national requirements, the maximum permitted draught;

(e) for other ships, 75 per cent of the moulded depth amidships as defined in Regulation 2(2).

REGULATION 5 CHANGE OF NET TONNAGE

(1) When the characteristics of a ship, such as V , V_c , d , N_1 or N_2 as defined in Regulations 3 and 4, are altered and where such an alteration results in an increase in its net tonnage as determined in accordance with the provisions of Regulation 4, the net tonnage of the ship corresponding to the new characteristics shall be determined and shall be applied without delay.

(2) A ship to which load lines referred to in sub-paragraphs (2)(a) and (2)(b) of Regulation 4 are concurrently assigned shall be given only one net tonnage as determined in accordance with the provisions of Regulation 4 and that tonnage shall be the tonnage applicable to the appropriate assigned load line for the trade in which the ship is engaged.

(3) When the characteristics of a ship such as V , V_c , d , N_1 or N_2 as defined in Regulations 3 and 4 are altered or when the appropriate assigned load line referred to in paragraph (2) of this Regulation is altered due to the change of the trade in which the ship is engaged, and where such an alteration results in a decrease in its net tonnage as determined in accordance with the provisions of Regulation 4, a new International Tonnage Certificate (1969) incorporating the net tonnage so determined shall not be issued until twelve months have elapsed from the date on which the current Certificate was issued; provided that this requirement shall not apply:¹⁸

¹⁸ The twelve month restriction prohibits a vessel from having lower net tonnages assigned on return voyages during which it is unladen (e.g., by having a lower load line assigned for that voyage).

- (a) if the ship is transferred to the flag of another State, or
- (b) if the ship undergoes alterations or modifications which are deemed by the Administration to be of a major character, such as the removal of a superstructure which requires an alteration of the assigned load line,¹⁹ or
- (c) to passenger ships which are employed in the carriage of large numbers of unberthed passengers in special trades, such, for example, as the pilgrim trade.

**REGULATION 6
CALCULATION OF VOLUMES**

R.6-1 Enclosed spaces above the upper deck, appendages and spaces open to the sea not exceeding 1 m³ should not be measured.

(1) All volumes included in the calculation of gross and net tonnages shall be measured, irrespective of the fitting of insulation or the like, to the inner side of the shell or structural boundary plating in ships constructed of metal, and to the outer surface of the shell or to the inner side of structural boundary surfaces in ships constructed of any other material.

(2) Volumes of appendages shall be included in the total volume.

R.6(2)-1 Bulbs, fairwaters, propeller shaft bossings or other structures should be treated as appendages.

R.6(2)-U1 Appendages which do not have enclosed volume, such as bearing struts, solid bilge keels, open frameworks and fenders, should not be measured.

(3) Volumes of spaces open to the sea may be excluded from the total volume.²⁰

R.6(3)-1 Hawse pipes, sea-valve recesses, thruster tunnels, stern chutes in fishing vessels, dredging wells in dredgers and other similar spaces fitted in the ship's hull should be dealt with as spaces open to the sea.²¹

R.6(3)-2 Volumes within the hulls of ships, such as split-hull barges and dredgers, should be retained in V and V_c notwithstanding that the space within the hull is temporarily opened to the sea when discharging cargo.

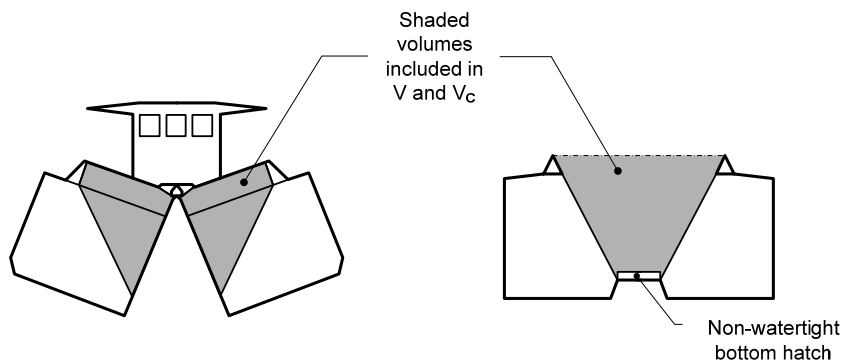

¹⁹ When applying this regulation, alterations or modifications that would necessitate remeasurement are deemed by the United States to be of a "major character".

²⁰ The United States tonnage regulations require all spaces meeting eligibility provisions for exclusion as open to the sea to be excluded from the total volume of all enclosed spaces (V). (See § 69.61(a) of this MTN.)

²¹ The United States applies this interpretation with the understanding that only those spaces which are below the upper deck and continuously in free communication with the sea or weather may be excluded as open to the sea. The U.S. Coast Guard Marine Safety Center (MSC-4) will provide determinations on what constitutes free communication in cases where flow restrictions call into question the classification of a space as open to the sea.

R.6(3)-3 Spaces open to the sea should not be excluded from the total volume of all enclosed spaces (V) if they are used for cargo and/or buoyancy purposes.

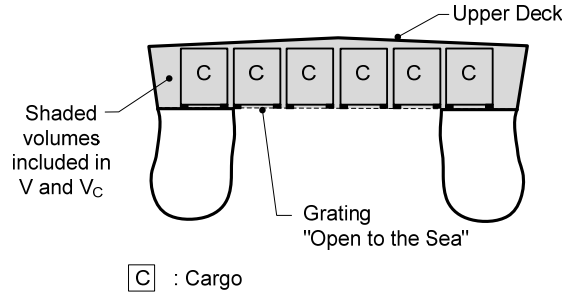

REGULATION 7 MEASUREMENT AND CALCULATION

R.7-1 When a tonnage certificate and a copy of the calculations of the tonnages are transmitted to another Government in accordance with article 8(2) or 10(3) of the Convention, they should be accompanied by a form as shown in the annex, showing the main particulars of the tonnage calculations for easy reference. When listing underdeck volumes, the volumes may be combined (e.g. underdeck/extended forecastle, etc.) on the form.

- (1) All measurement used in the calculation of volumes shall be taken to the nearest centimetre or one-twentieth of a foot.
- (2) The volumes shall be calculated by generally accepted methods for the space concerned and with an accuracy acceptable to the Administration.²²

R.7(2)-1 Administrations should decide on the degree of accuracy required for the tonnage calculations.

- (3) The calculation shall be sufficiently detailed to permit easy checking.

²² The United States tonnage regulations provide for volumes to be calculated according to accepted naval architectural practices. (See § 69.65 of this MTN for additional details.)

**APPENDIX 1
 FIGURES REFERRED TO IN REGULATION 2(5)**

In the following figures: O = excluded space.
 C = enclosed space.
 I = space to be considered as an enclosed space.

Hatched in parts to be included as enclosed spaces.
 B = breadth of the deck in way of the opening. In ships with rounded gunwales the breadth is measured as indicated in Figure 11.

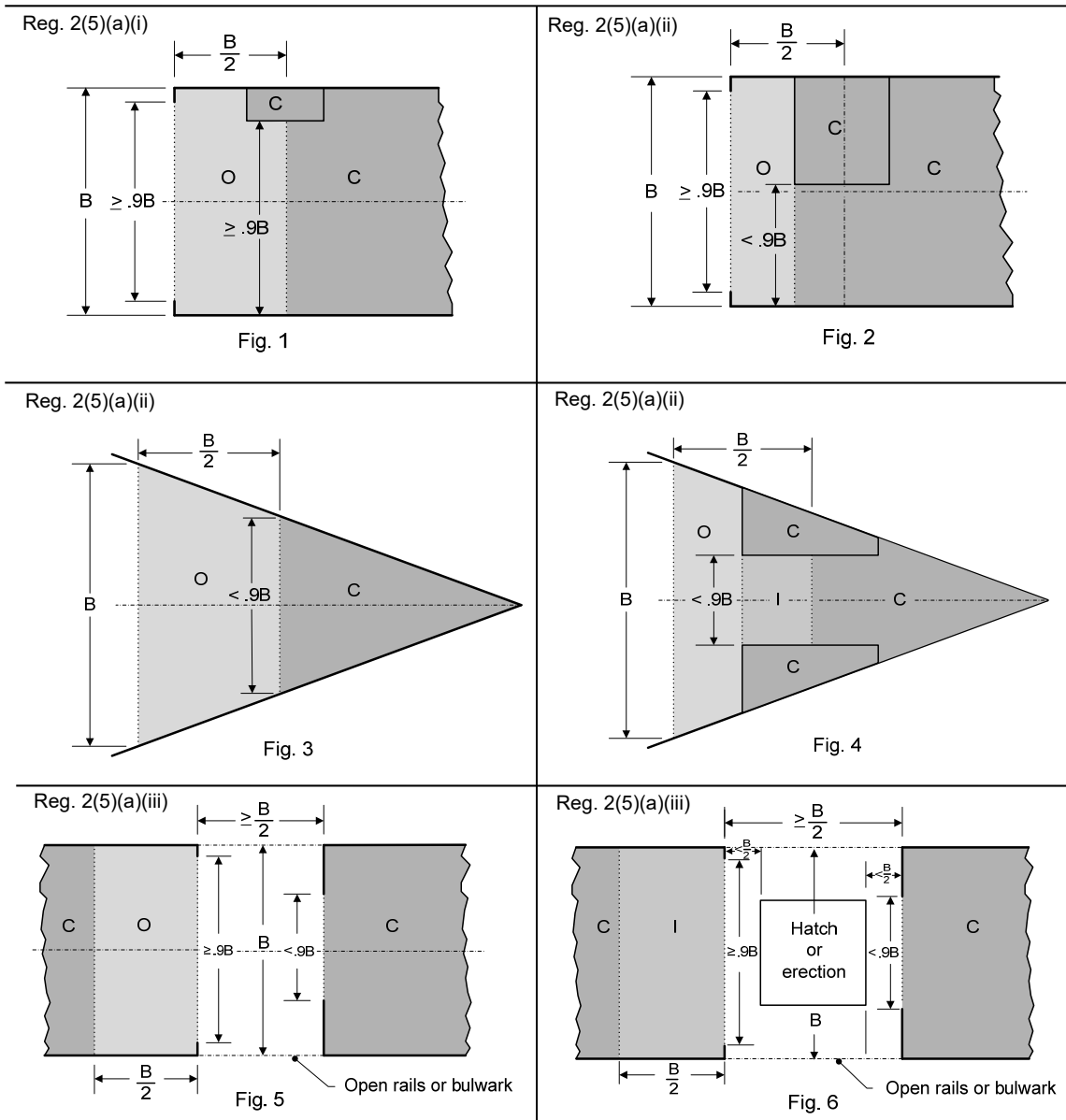

Reg. 2(5)(b)

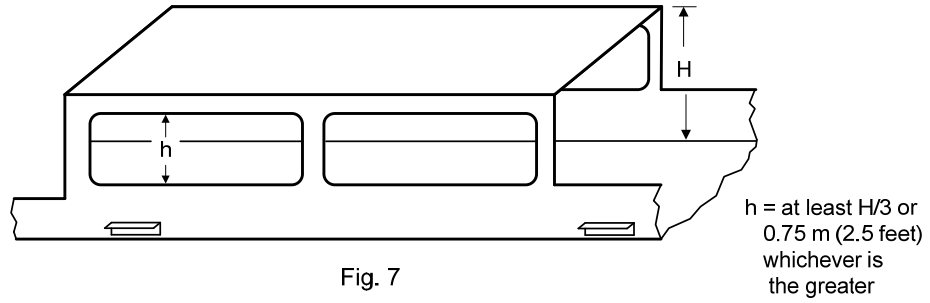

Fig. 7

Reg. 2(5)(c)

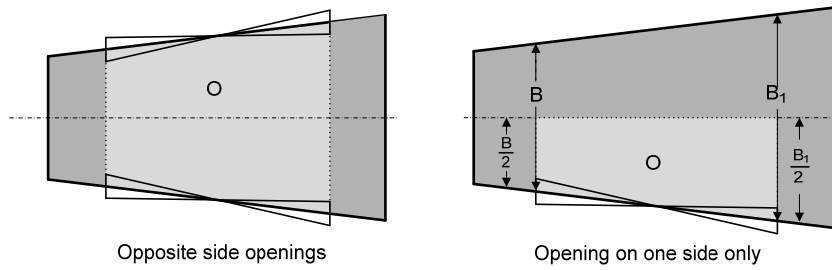
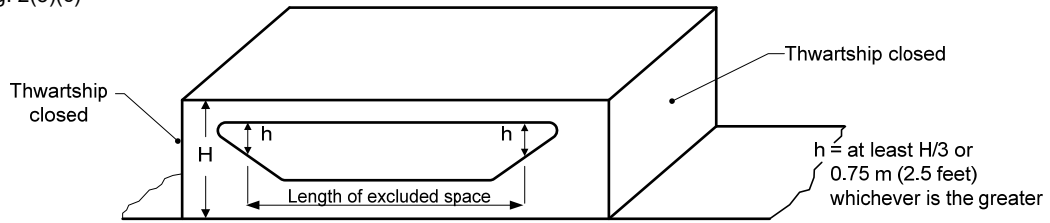

Fig. 8

Reg. 2(5)(d)

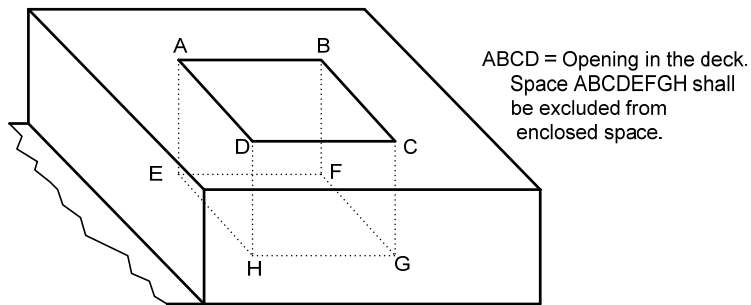

Fig. 9

Reg. 2(5)(e)

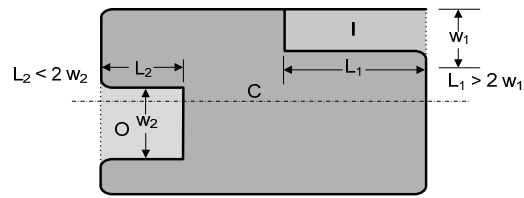

Fig. 10

Ships With Rounded Gunwales

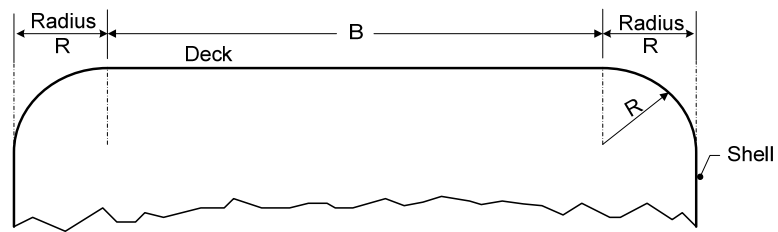

Fig. 11

APPENDIX 2
COEFFICIENTS K1 AND K2 REFERRED TO IN REGULATIONS 3 AND 4(1)

V or V_c = Volume in cubic metres

V or V _c	K ₁ or K ₂	V or V _c	K ₁ or K ₂	V or V _c	K ₁ or K ₂	V or V _c	K ₁ or K ₂
10	0.2200	45,000	0.2931	330,000	0.3104	670,000	0.3165
20	0.2260	50,000	0.2940	340,000	0.3106	680,000	0.3166
30	0.2295	55,000	0.2948	350,000	0.3109	690,000	0.3168
40	0.2320	60,000	0.2956	360,000	0.3111	700,000	0.3169
50	0.2340	65,000	0.2963	370,000	0.3114	710,000	0.3170
60	0.2356	70,000	0.2969	380,000	0.3116	720,000	0.3171
70	0.2369	75,000	0.2975	390,000	0.3118	730,000	0.3173
80	0.2381	80,000	0.2981	400,000	0.3120	740,000	0.3174
90	0.2391	85,000	0.2986	410,000	0.3123	750,000	0.3175
100	0.2400	90,000	0.2991	420,000	0.3125	760,000	0.3176
200	0.2460	95,000	0.2996	430,000	0.3127	770,000	0.3177
300	0.2495	100,000	0.3000	440,000	0.3129	780,000	0.3178
400	0.2520	110,000	0.3008	450,000	0.3131	790,000	0.3180
500	0.2540	120,000	0.3016	460,000	0.3133	800,000	0.3181
600	0.2556	130,000	0.3023	470,000	0.3134	810,000	0.3182
700	0.2569	140,000	0.3029	480,000	0.3136	820,000	0.3183
800	0.2581	150,000	0.3035	490,000	0.3138	830,000	0.3184
900	0.2591	160,000	0.3041	500,000	0.3140	840,000	0.3185
1,000	0.2600	170,000	0.3046	510,000	0.3142	850,000	0.3186
2,000	0.2660	180,000	0.3051	520,000	0.3143	860,000	0.3187
3,000	0.2695	190,000	0.3056	530,000	0.3145	870,000	0.3188
4,000	0.2720	200,000	0.3060	540,000	0.3146	880,000	0.3189
5,000	0.2740	210,000	0.3064	550,000	0.3148	890,000	0.3190
6,000	0.2756	220,000	0.3068	560,000	0.3150	900,000	0.3191
7,000	0.2769	230,000	0.3072	570,000	0.3151	910,000	0.3192
8,000	0.2781	240,000	0.3076	580,000	0.3153	920,000	0.3193
9,000	0.2791	250,000	0.3080	590,000	0.3154	930,000	0.3194
10,000	0.2800	260,000	0.3083	600,000	0.3156	940,000	0.3195
15,000	0.2835	270,000	0.3086	610,000	0.3157	950,000	0.3196
20,000	0.2860	280,000	0.3089	620,000	0.3158	960,000	0.3196
25,000	0.2880	290,000	0.3092	630,000	0.3160	970,000	0.3197
30,000	0.2895	300,000	0.3095	640,000	0.3161	980,000	0.3198
35,000	0.2909	310,000	0.3098	650,000	0.3163	990,000	0.3199
40,000	0.2920	320,000	0.3101	660,000	0.3164	1,000,000	0.3200

Coefficients K₁ or K₂ at intermediate values of V or V_c shall be obtained by linear interpolation.

ANNEX II²³
CERTIFICATE

INTERNATIONAL TONNAGE CERTIFICATE (1969)

(Official seal)

Issued under the provisions of the International Convention on Tonnage Measurement of Ships, 1969, under the authority of the Government of
(full official designation of country)
for which the Convention came into force on19..
by
(full official designation of the competent person or organization recognized under the provisions of the International Convention on Tonnage Measurement of Ships, 1969.)

Name of Ship	Distinctive Number or Letters	Port of Registry	*Date

*Date on which the keel was laid or the ship was at a similar stage of construction (Article 2(6)), or date on which the ship underwent alterations or modifications of a major character (Article 3(2)(b)), as appropriate.

MAIN DIMENSIONS

Length (Article 2(8))	Breadth (Regulation 2(3))	Moulded Depth amidships to Upper Deck (Regulation 2(2))

THE TONNAGES OF THE SHIP ARE:

GROSS TONNAGE

NET TONNAGE

This is to certify that the tonnages of this ship have been determined in accordance with the provisions of the International Convention on Tonnage Measurement of Ships, 1969.

Issued at 19..
(place of issue of certificate) (date of issue)

.....
(signature of official issuing the certificate)
and/or
(seal of issuing authority)

If signed, the following paragraph is to be added:
The undersigned declares that he is duly authorized by the said Government to issue this certificate.

.....
(Signature)

SPACES INCLUDED IN TONNAGE					
GROSS TONNAGE			NET TONNAGE		
Name of Space	Location	Length	Name of Space	Location	Length
Underdeck	-	-			
			NUMBER OF PASSENGERS (Regulation 4(1)) Number of passengers in cabins with not more than 8 berths Number of other passengers		
EXCLUDED SPACES (Regulation 2(5)) An asterisk (*) should be added to those spaces listed above which comprise both enclosed and excluded spaces.			MOULDED DRAUGHT (Regulation 4(2))		
Date and place of original measurement					
Date and place of last previous remeasurement					
REMARKS:					

²³ Model certificate from the authentic English version of the 1969 Tonnage Convention. The United States notes that the Excluded Spaces block was not intended for the listing of excluded spaces.

ANNEX III
VERIFICATION OF COMPLIANCE WITH THE PROVISIONS OF
THIS CONVENTION

REGULATION 8
APPLICATION

Contracting Governments shall use the provisions of the Code for Implementation in the execution of their obligations and responsibilities contained in the present Convention.

REGULATION 9
VERIFICATION OF COMPLIANCE

- (1) Every Contracting Government shall be subject to periodic audits by the Organization in accordance with the audit standard to verify compliance with and implementation of the present Convention.
- (2) The Secretary-General of the Organization shall have responsibility for administering the Audit Scheme, based on the guidelines developed by the Organization.
- (3) Every Contracting Government shall have responsibility for facilitating the conduct of the audit and implementation of a programme of actions to address the findings, based on the guidelines developed by the Organization*.
- (4) Audit of all Contracting Governments shall be:
 - .1 based on an overall schedule developed by the Secretary-General of the Organization, taking into account the guidelines developed by the Organization*; and
 - .2 conducted at periodic intervals, taking into account the guidelines developed by the Organization.

NOVEL CRAFT INTERPRETATIONS (REGULATION 1(3))

NvICr. 1 Livestock carriers

N.1-1 Livestock carriers are most often converted ships. Above the existing upper deck, one or more decks are constructed. Between these decks, the livestock corrals and their associated spaces are arranged, separated by, for example, railings, fences or gangways. The corrals are open to the air.

N.1-2 Stanchions, fences and railings to keep livestock in the corrals are “other means for securing cargo” according to Regulation 2(5).

N.1-3 In applying the provisions of the 1969 Tonnage Convention, livestock structures should be included in the gross tonnage.

NvICr. 2 Dockships

N.2-1 A dockship may include in its main structural characteristics the absence of hatch covers above the cargo space but may have a dock deck above the moulded draught together with side erections.

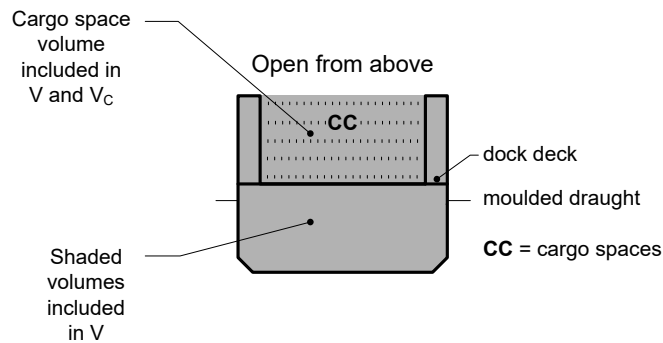

N.2-2 The dockships considered are described as:

- .1 a dockship open-ended at the stern,

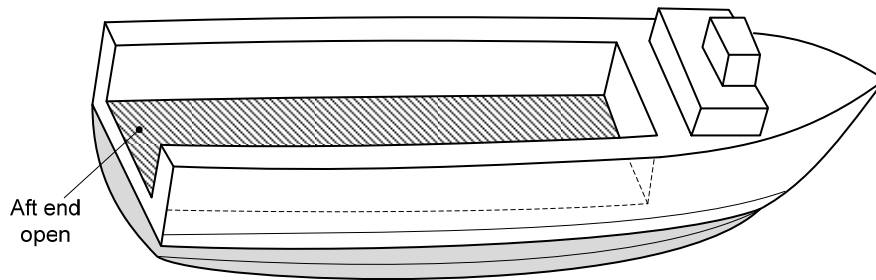

.2 a dockship fitted with a stern door or a grill stern door. (See Figure 8 in appendix 1.)

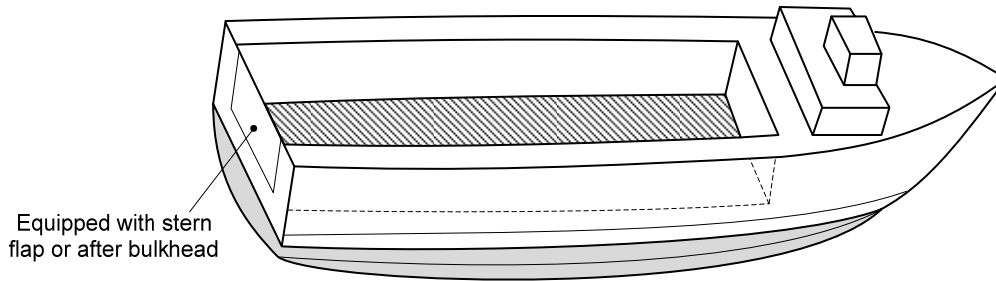

N.2-3 The space above the dock deck, bounded on at least three sides by erections and intended for the carriage of cargo should be included.

N.2-4 In this context, an erection is defined as being an enclosed space bounded by bulkheads and a deck above.

NvICr. 3 Open-top containerships

N.3-1 Refer to resolution MSC.234(82) for "Recommendations concerning tonnage measurement of open-top containerships."

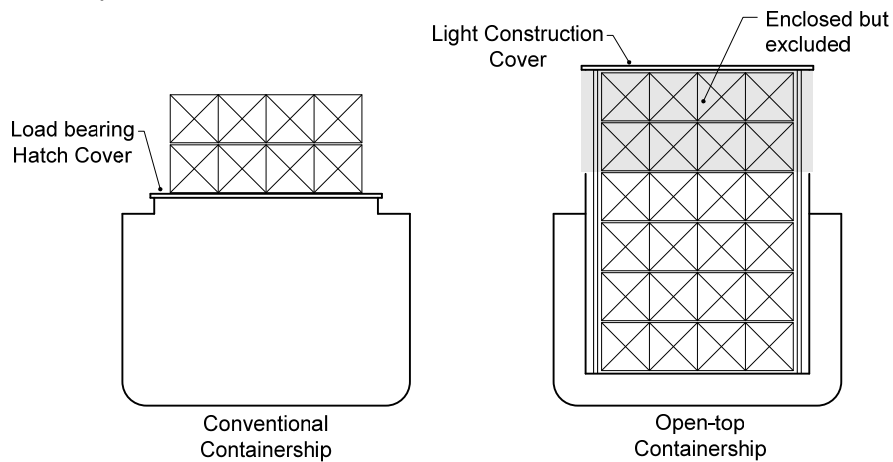

(U.S.)

Nv/Cr. 4 Offshore supply vessels

N.4-1 (U.S.) *The uncovered cargo deck space on an offshore supply vessel (OSV) is not considered an enclosed space under the provisions of Regulation 1(3), notwithstanding the presence of bulwarks or other enclosing structures, regardless of their height. In this context, the cargo deck space is defined as the open space on the main deck aft of the forecandle that is exposed to weather and used for stowage of deck cargo loads and/or processing equipment. This determination applies to all self-propelled vessels engaged primarily in towing, anchor handling, transport of stores, materials and equipment to offshore installations and designed with accommodation and bridge erections in the forward part of the vessel and an exposed cargo deck in the after part for the handling of cargo at sea.²⁴*

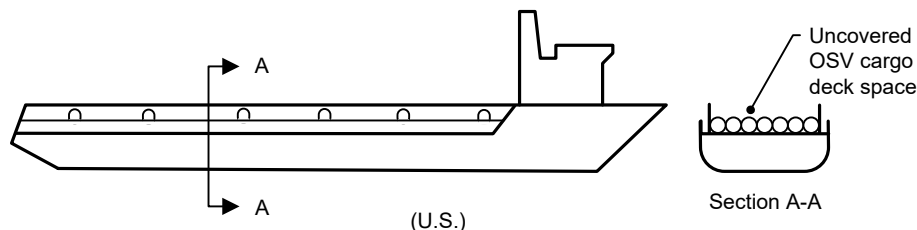

Nv/Cr. 5 Vessels with qualifying segregated ballast tanks

N.5-1 (U.S.) *The formula for Reduced Gross Tonnage of a vessel with qualifying segregated ballast tanks is provided below. To be considered qualifying segregated ballast tanks, the tanks must have a separate ballast pumping and piping system arranged for the intake and discharge of ballast water from and to the sea only. In addition, there must be no piping connections from segregated ballast tanks to the fresh water system, and the tanks must not be used for the carriage of any cargo or for the storage of ship's stores or material.²⁵*

$$GT_r = GT_{ITC} - K_1 V_b$$

in which:

GT_{ITC} is as calculated in § 69.57

K₁ is as calculated in § 69.57

V_b is the total volume of qualifying segregated ballast tanks, calculated in cubic meters.

²⁴ See IMO circular TM/Circ.89 dated 15 January 2002.

²⁵ IMO Resolutions A.747(18) and MSC.234(82) provide for the calculation of a Reduced Gross Tonnage (GT_r) for qualifying vessels upon request of the vessel owner. Reduced Gross Tonnage is intended to encourage favorable economic treatment of vessels whose designs incorporate specific features. For applicable vessels, a remark is included on a qualifying vessel's International Tonnage Certificate (1969), citing the Reduced Gross Tonnage and referring to the use of Reduced Gross Tonnage for the "calculation of tonnage based fees."

ANNEX TO CIRCULAR TM.5/CIRC.6

FORM GIVING PARTICULARS OF UNIFORM TONNAGE CALCULATION

GROSS TONNAGE

Item No.	Name of Space	Location	Length	Moulded volume
	Underdeck Poop Bridge Forecastle Deckhouses Hatches, etc.			
		Total volume		
NET TONNAGE				
	No. 1 hold No. 2 hold, etc. No. 1 tween decks, etc. No. 2 tween decks, etc. Hatches, etc.			
		Total volume		

APPENDIX C RECOMMENDATIONS OF THE CONFERENCE¹

The following are the Recommendations adopted by the Conference:

RECOMMENDATION 1 ACCEPTANCE OF THE INTERNATIONAL CONVENTION ON TONNAGE MEASUREMENT OF SHIPS, 1969

The Conference recommends that Governments should accept the International Convention on Tonnage Measurement of Ships, 1969, at as early a date as possible.

RECOMMENDATION 2 USES OF GROSS AND NET TONNAGES

The Conference recommends that the gross tonnage and the net tonnage as determined in accordance with the provisions of the International Convention on Tonnage Measurement of Ships, 1969, should be accepted as the parameters referred to where those terms are used in conventions, laws and regulations, and also as the basis for statistical data relating to the overall size or useful capacity of merchant ships. In addition, recognizing that the transition from existing tonnage measurement systems to the new system provided in the Convention should cause the least possible impact on the economics of merchant shipping and port operations, the Conference recommends that Contracting Governments, port authorities, and all other agencies which use tonnage as a basis for charges should carefully consider which parameter is most appropriate for their use in the light of their present practice.

RECOMMENDATION 3 UNIFORM INTERPRETATION OF DEFINITION OF TERMS

The Conference, recognizing that the definitions of certain terms used in the International Convention on Tonnage Measurement of Ships, 1969, such as "length", "breadth", "passenger" and "weathertight", are identical to those contained in other conventions of which the Inter-Governmental Maritime Consultative Organization is depositary, recommends that Contracting Governments should take steps to ensure that identical definitions of terms used in such conventions are interpreted in a uniform and consistent manner.

¹ Recommendations of the International Conference on Tonnage Measurement of Ships, 1969.

(Page intentionally left blank)

APPENDIX D DISCUSSION OF CHANGES

46 CFR 69 SUBPART A - GENERAL

1. **§ 69.9 Substantially Altered Date** - This definition from Navigation and Vessel Inspection Circular (NVIC) 11-93 CH-3, *Applicability of Tonnage Measurement Systems to U.S. Flag Vessels*, was added to facilitate understanding of Subpart A.
2. **§ 69.20(b) Thresholds Found in International Conventions** - A footnote was added referencing the 2013 International Maritime Organization (IMO) resolution addressing use of national tonnage thresholds in applying international conventions, including international tonnage grandfathering provisions

46 CFR 69 SUBPART B - CONVENTION MEASUREMENT SYSTEM

1. **General** - Additional interpretive text was deleted or relocated to Appendix B, as appropriate, without substantive change, further to the changes for this subpart made by MTN 01-99 CH-9 that incorporated IMO and International Association of Classification Societies (IACS) interpretations. This results in additional consolidation of interpretive information in a single location, facilitating its use by measurement organizations that perform measurement work using the rules of the 1969 Tonnage Convention on behalf of other flag Administrations.
2. **§ 69.53 Registered Length** - As part of the changes to consolidate interpretations in Appendix B, the previous U.S. interpretations that treated multihull vessels differently from monohull vessels were fully aligned with international interpretations, which make no such distinction. This may result in future registered length assignments for certain multihull vessels that are less than assignments under previous interpretations.

46 CFR 69 SUBPART C - STANDARD REGULATORY MEASUREMENT SYSTEM

1. **§ 69.108(b)(3) Restrictions** - The interpretive figure was revised to include an example illustrating how the “one-half the tonnage length” criterion is applied in a situation involving non-contiguous “ceiling on floors”.
2. **§ 69.109(f)(2) Vessel with Headblock or Square End** - The interpretive figure was revised to better illustrate the application of requirements for terminating the tonnage length on the inboard faces of qualifying ordinary frames, as reflected in a decision letter dated 2/25/2011.
3. **§ 69.109(o)(3) Restrictions on Smaller Vessels** - This section was revised to clarify that the “midship depth” used in applying open vessel provisions is take at the mid-point of the vessel’s tonnage length, as opposed to the vessel’s overall length, based on review of relevant language in the earlier editions of the tonnage regulations, and associated correspondence, dating to 1939.
4. **§ 69.109(p)(1)(i) Frame Intersection** - This section was revised to expand upon and clarify interpretive text following a comprehensive review of treatment of smaller frame-edge openings - such as limber holes - when applying ordinary framing provisions of the tonnage regulations. This included consideration of Ship Structure Committee Report SSC-226, *Review of Ship Structural Details* (1977), and a review of relevant Coast Guard decision letters dating to 1944. The revisions establish a 50% attachment criterion for vessels of other than wooden construction. This maintains the restriction on full penetration through frame cutouts, as reflected in decision letters dated 12/16/1987, 5/20/2004, 6/14/2004, 1/11/2008, 3/14/2011, 10/10/2013 and 3/23/2017, while allowing for relatively small openings, consistent with the under-deck measurement

principles of the tonnage regulations and underlying statute, and decision letters dated 7/8/2019 and 7/11/2019. More restrictive interpretations requiring continuous welding along 100% of the intersecting frame's perimeter are superseded, including those reflected in decision letters dated 1/26/1996, 8/12/2009, 7/2/2012, 9/26/2018 and 12/19/2018. An associated figure was added to illustrate a common frame intersection configuration involving a cutout.

5. **§ 69.109(p)(7)(v)(2) Transverse Side Frames and Longitudinal Bottom Frames** - The figures were updated for consistency with the revised frame penetration interpretations of § 69.109(p)(1)(i).

6. **§ 69.109(q)(8) Wet Deck Area** - This section was revised to delete redundant information on exclusion of spaces open to the sea, as well as an incorrect reference to an outdated section of the MTN, which had been renumbered in an earlier MTN change.

7. **§ 69.117(d)(1)(iii) Treatment of Spaces Outside of Boundary Bulkheads** - The interpretive figure was revised to delete the term "uncovered", which was intended to refer to whether the opening was fitted with a covering, but could be read as referring to whether the associated portion of the structure was missing an overhead covering.

8. **§ 69.117(d)(3)(i)(1)(a) Interior vs. Exterior Openings** - The interpretive figure was revised to clarify that the depicted after bulkhead opening is not fitted in an exterior bulkhead. The figure was additionally revised to clarify that progression of open space is not permitted through an opening fitted in the transverse bulkhead of a recess space that does not qualify as both an excluded space and an exempted space. This was the subject of decision letters dated 5/2/2019 and 5/24/2019. In addition, the term "uncovered" was deleted, for the reason cited for the change to § 69.117(d)(1)(iii), and text in both the figure and the section were generalized to address the case of a structure with its aft end entirely open per § 69.117(d)(7).

9. **§ 69.117(d)(3)(ii) Progression of Open Space From Excluded Space** - The interpretive figure was revised to delete the term "uncovered", for the reason cited for the change to § 69.117(d)(1)(iii).

46 CFR 69 SUBPART D - DUAL REGULATORY MEASUREMENT SYSTEM

1. **§ 69.167 Superstructure Tonnage** - An interpretive figure was added to illustrate treatment of a forecastle space beneath a deck that qualifies as part of the uppermost complete deck under the Dual Regulatory Measurement System, consistent with decision letters dated 2/11/2011, 3/3/2011, 12/27/2012, 2/15/2013, 4/5/2013, and 10/30/2014.

APPENDIX B - 1969 TONNAGE CONVENTION

1. **Int R.2(2)-U1 Moulded Depth** - This U.S. interpretation on the molded depth of vessels that are not monohulls was relocated from Subpart B as part of the consolidation discussed above under the Subpart B changes, and is applied when assigning a vessel's registered depth.

2. **Int R.2(4)-8 Open Gratings** - A footnote was added reflecting the U.S. understanding that deck boards with drainage gaps do not constitute open gratings, based on a decision letter dated 5/23/2017.

3. **Reg. 2(8)-(12) Audit Provisions** - These new regulations were added per IMO Assembly Resolution A.1084(28), *Tonnage Convention Amendments*, adopted on December 4, 2013, to make use of the IMO Instruments Implementation Code (III Code) mandatory. Per IMO document C 117/17, *Report on the Status of Conventions and Other Multilateral Instruments in Respect of Which the Organization Performs Functions*, the conditions for these amendments were met on February 28, 2016, with entry into force on February 28, 2017.

4. **Annex III Verification of Compliance with the Provisions of this Convention** - This new annex is a reprint of the new annex added per IMO Assembly Resolution A.1084(28).
5. **NvlCr.5 - Vessels with Qualifying Segregated Ballast Tanks** - This U.S. novel craft interpretation was relocated from Subpart B as part of the consolidation discussed above under the Subpart B changes, and addresses optional reduced gross tonnage assignments.